



Content Oriented Routing and Forwarding

Eugen Borcoci,
University POLITEHNICA Bucharest,
Eugen.Borcoci@elcom.pub.ro

Daniel Negru,
CNRS-LaBRI Lab. University of Bordeaux, France



Content Oriented Routing and Forwarding



Acknowledgement

The **overview (State of the Art) part is not original work, except the structuring and presentation of the material; it is prepared**, based on several public documents and different authors' and groups work: FI conferences public material, research papers and projects, overviews, tutorials, etc.: (see Reference list)

The **ALICANTE –project case study** as an example of content/media –oriented architecture contains part of the ALICANTE consortium work and is presented with permission of the ALICANTE Consortium.

This work is supported by **ALICANTE FP7 IP Project 248652: “Media Ecosystem Deployment Through Ubiquitous Content-Aware Network Environments”**.



Content Oriented Routing and Forwarding



Motivation of this talk

- **(ICN) Information Centric Networking**
- **(CON) Content Oriented Networking**
- **(CON) Content Centric Networking ..**
 - received recently significant attention of the research community and also of industry and operators
 - propose some fundamental changes for TCP/IP networking
 - claiming several advantages in the perspective of Future Internet
- **Still open questions:**
 - what significant benefits does ICN designs offer?
 - are ICN designs the best solution to achieve those benefits?
 - Is the current technology prepared to introduce soon these changes?



CONTENTS



1. Introduction: Future Internet -Trends and Challenges
2. Content and Services Oriented Networking
3. Content Oriented Routing and Forwarding
4. Comparison of ICN/CON Approaches
5. ALICANTE Project Solutions
6. Conclusions



CONTENTS



1.  **Introduction: Future Internet -Trends and Challenges**
2. Content and Services Oriented Networking
3. Content Oriented Routing and Forwarding
4. Comparison of ICN/CON Approaches
5. ALICANTE Project Solutions
6. Conclusions



1. Future Internet- Trends and Challenges



■ Future Internet

- Internet : major impact on *all socio-economic and life aspects* of the global society
- Current internet : many limitations, not designed for a global scale and integrated services, ossification, ..
- Many efforts to revisit/re-define the FI development directions
 - points of view: technical, economical, social, evolution, etc.
- Entities involved: Research groups, Academia, Industry, Standardization organizations, Governments, Users, ..
- Still – there are many open FI issues, including discussion/revision of the basic concepts



1. Future Internet- Trends and Challenges



- **Future Internet**
 - **Partial list of FI initiatives/projects/...**
 - GENI Global Environment for Network Innovations, NSF
 - FIRE Future Internet Research and Experimentation - European program
 - European Future Internet Portal
 - FIA - Future Internet Assembly
 - EU ICT FP7 Future Internet projects
 - FIND - Future Internet network design
 - Clean Slate Research Program - Stanford University
 - TARIFA - The Atomic Redesign of the Internet Future Architecture
 - ITU-T Study Group 13 (SG13) on Future Networks , mobile and NGN, focus group FG-FN, Q21/13
 - ITFAN Inter-Agency Task Force for Advanced Networking (USA)
 - it839/u-it839 (Korea)
 - it839/u-it839 and FIF (FIForum) funded by MIC (Korea) <http://www.fif.kr/>
 - NICTA (Australia)
 - ANR (France)
 - ICT SHOK (Finland))



1. Future Internet- Trends and Challenges



- **Source: Fundamental Limitations of current Internet and the path to Future Internet** EC FIArch Group2, Release Date: 1 March 2011
- http://ec.europa.eu/information_society/activities/foi/docs/current_internet_limitations_v9.pdf
- *Processing/handling of “data”:*
 - low possibility for hosts to diagnose potential network problems
 - low feedback from the network
 - lack of data and service identity
 - low data integrity, reliability, provenance, and trust
- *Data transport :* lack of efficient delivery of content-oriented traffic
- *Control of processing, storage, transmission of systems and functions:*
 - low flexibility and adaptive control
 - no common reference architecture of the IP control plane (numerous control components added to the original IP simple data plane)
 - lack of efficient congestion control
- *Multi-category limitations:*
 - traffic growth versus heterogeneity in capacity distribution
 - the current inter-domain routing system is reaching fundamental limits
 - still low security



1. Future Internet- Trends and Challenges



- **Source: Management and Service-aware Networking Architectures (MANA) Group :**
- *A. Galis et. al., “Management and Service-aware Networking Architectures (MANA) for Future Internet Position Paper: System Functions, Capabilities and Requirements”, <http://www.future-internet.eu/home/future-internet-assembly/prague-may-2009>*
- **Curent Internet Problems **not** (fully) solved:**
 - **Guaranteed availability** of service according to SLAs and facilities to support QoS
 - **Mobility of services**
 - **Inherent network management** and self-management functionality
 - **Management overhead** (critical part of lifecycle costs)
 - **Large scale provisioning** and deployment of both services and management
 - Support for **higher integration between services and networks.**
 - **Facilities for**
 - **addition of new functionality,**
 - **activating a new service on-demand,** network functionality, or protocol (i.e. addressing the **ossification** bottleneck
 - **Security, reliability, robustness, context- awareness**
 - **Service support, orchestration and management** for communication and services' resources.



1. Future Internet- Trends and Challenges



- **Source: Future Media Internet Architecture Reference Model**

- [www.fi-nextmedia.eu /](http://www.fi-nextmedia.eu/)

- *Improvement proposed by FMIA group*

- Content ***Dynamic caching*** In-network:

- efficiency increase
- network nodes store content (routers, servers, nodes, data centres) – closer to the users

- ***Content Identification***

- routers could identify/analyse *content_type* and/or *content_objects* and process packets efficiently in terms of routing, forwarding, filtering, multiplication, etc.

- ***Network topology & traffic knowledge***

- the current best/better E2E path could be selected for data delivery, if knowledge about the network topology /traffic per link were known, by some other entities than the network ones only

- ***Content Centric Delivery:***

- more efficient content-aware delivery - based on the content name, if the content caching location, the network topology and traffic were known, rather than initial location of the content only

- ***Dynamic Content Adaptation & Enrichment:*** based on user preferences and user/network context



1. Future Internet- Trends and Challenges



- **Future Media Internet Architecture Reference Model**
 - **FI Design principles (valid also for FMIA)**
 - Support **flexible business models**
 - multiple stakeholders can , open environment
 - encouraging innovation and participation without barriers
 - **Open architectures and protocols**
 - enable increased competition between providers(NP, SP, ..)
 - Users -> “prosumers”
 - **Higher participation of individuals**, communities and small businesses + and more established organizations
- Incentives **for CP/SPs** to receive appropriate benefits for their contribution
- FI :
 - **sustainable network** , flexible for evolution, development and extension - in response to market
 - **scalable, available and reliable** (resources versus cost)

- **Source: Future Media Internet Architecture Reference Model**

- [www.fi-nextmedia.eu /](http://www.fi-nextmedia.eu/)
- <http://initiative.future-internet.eu/news/view/article/future-media-internet-architecture-reference-model-white-paper.html>- 2011

- **Current Internet limitations-related to content delivery**

- *Components*

- *Content Servers or Content Caches (Content Provider or user generated content and services),*
- *Search Engines (centralised or clustered)*
- *Network Nodes (Routers - edge and core and, Residential Gateways)*
- *User terminals*

- *Phases: 1-4, to get content*

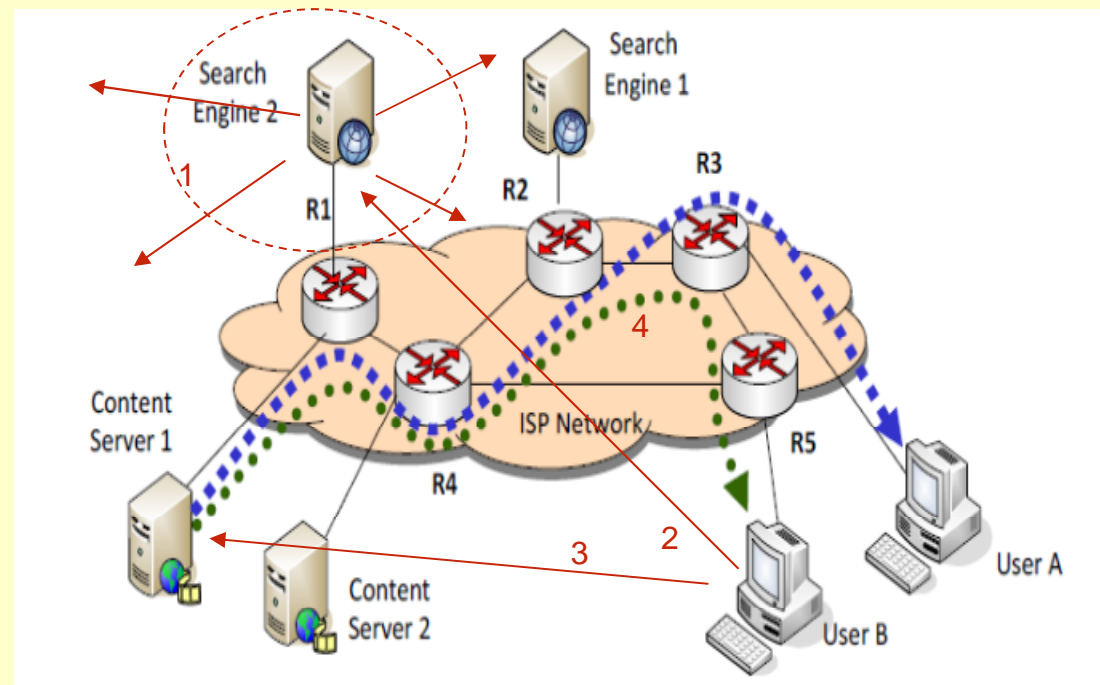

Source: <http://initiative.future-internet.eu/news/view/article/future-media-internet-architecture-reference-model-white-paper.html>- 2011

1. Future Internet- Trends and Challenges

- **Source: Future Media Internet Architecture Reference Model**
 - www.fi-nextmedia.eu/
 - **High –level FMI Network Architecture**

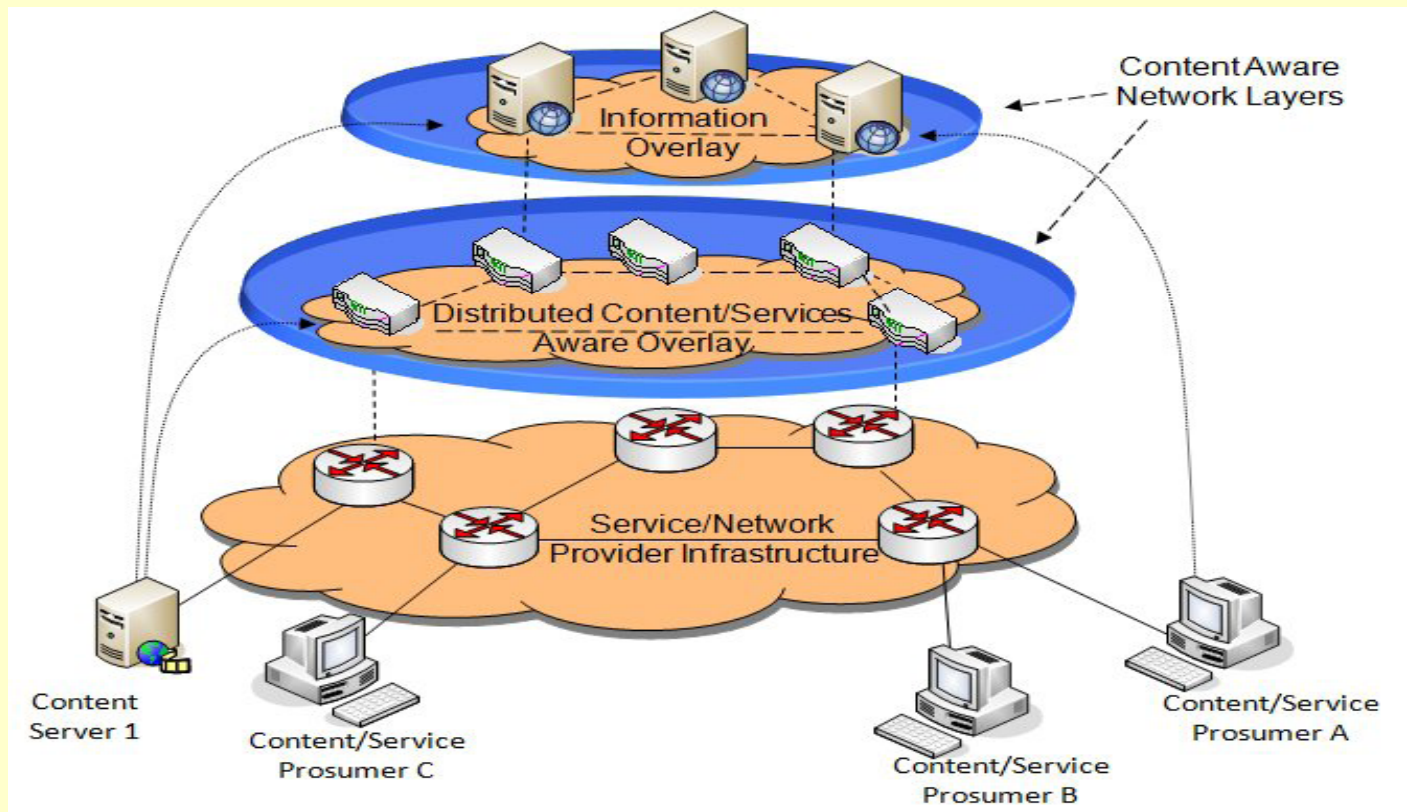



1. Future Internet- Trends and Challenges



- **Source: Future Media Internet Architecture Reference Model**
 - [www.fi-nextmedia.eu /](http://www.fi-nextmedia.eu/)

- **High –level FMI Network Architecture (cont'd)**
 - nodes may belong to more than one layer

- FMI deployment –still incremental
 - legacy network nodes will remain for a number of years;
 - architecture : backward compatible with current Internet deployment

- ***Service/Network Provider Infrastructure***
 - Lower layers
 - Users can be “Prosumers”
 - Usually the owner is ISP/network provider
 - Limited functionality and intelligence nodes
 - Content will be routed, **assuming basic quality requirements** and if possible cached in this layer



1. Future Internet- Trends and Challenges



- **Source: Future Media Internet Architecture Reference Model**
 - [www.fi-nextmedia.eu /](http://www.fi-nextmedia.eu/)
- **High –level FMI Network Architecture (cont'd)**
- ***Distributed Content/Services Aware Overlay***
 - **Content-Aware Network** Nodes (edge routers, home gateways, terminals devices)
 - **Intelligent nodes** can filter content and Web services flowing through (e.g. via DPI, signalling processing),
 - identify streaming sessions and traffic (via signalling analysis) and provide qualification of the content.
 - information reported to the *Information Overlay*
 - **Virtual overlays** –at this layer - statically/dynamically constructed
 - specific purposes: content caching, content classification, indexing, network monitoring, content adaptation, optimal delivery/streaming
 - Content delivery modes; hybrid client-server and/or P2P
 - Nodes have information on the content and the content type/context that they deliver → hybrid topologies may be constructed, customised for streaming complex media
 - Scalable Video Coding (SVC), Multi-view Video Coding (MVC)



1. Future Internet- Trends and Challenges



- **Source: Future Media Internet Architecture Reference Model**
 - [www.fi-nextmedia.eu /](http://www.fi-nextmedia.eu/)

- **High –level FMI Network Architecture (cont'd)**

- ***Information Overlay (IO)***
- intelligent nodes/servers having distributed knowledge of
 - content/web-service location/caching
 - (mobile) network instantiation/ conditions (**limited**)

- Types of nodes:
 - unreliable peers in a P2P topology
 - secure corporate routers
 - Data Centres in a distributed carrier-grade cloud network

- Factors determining variation: actual network deployment and instantiation, the service scenario/requirements, service quality agreements

- Content stored/cached : at the *Information Overlay* or at lower hierarchy layers

- *IO allows* awareness of the content/services location/caching and the network information
 - decision --> content optimally retrieved and delivered to the subscribers or inquiring users or services



1. Future Internet- Trends and Challenges



- Source: Future Media Internet Architecture Reference Model
- **Actions in the content production and delivery workflow**
 - **Content production:**
 - generation and store in a server
 - associated metadata (created manually/ automatically)
 - **Publishing** inside the FMI network (manual publishing procedure or automatic content discovery and identification procedure)
 - **Search by the CC** using a search engine.
 - A user can directly consume content utilizing the FMI network if he/she knows exactly the content item he/she is looking for.
 - **Caching** by different cache nodes - as the content is delivered in the FMI overlay network (different criteria and policies)
 - **Content** consumption by the CC
- **Network**
 - may also analyze the content being requested to be transported through it. (this information could be used by the search engine)
 - monitor its own state, as for example the connectivity between nodes, in order to report it to various components.



CONTENTS



1. Introduction: Future Internet -Trends and Challenges
2.  **Content and Services Oriented Networking**
3. Content Oriented Routing and Forwarding
4. Comparison of ICN/CON Approaches
5. ALICANTE Project Solutions
6. Conclusions



2. Content and Services Oriented Networking



- **Terminology**
 - Not standardised, different (overlapping) semantics...
 - **ICN - Information Centric Networking**
 - **CON - Content Oriented Networking**
 - **CCN - Content Centric Networking**
 - **DON - Data Oriented Networking**
 - **CAN - Content Aware Networking**
 - **NDN - Named Data Networking**
 - **Related terminology:**
 - **SON – Service Oriented Networking**
 - **NAA- Network Aware Applications**
 - **What are relationships between these names?**
 - **Examples of ICN/CON Projects**
 - EUROPE :
PSIRP, 4WARD, PURSUIT, SAIL, ALICANTE, ..
 - USA
CCN , DONA , NDN, ...



2. Content and Services Oriented Networking



■ ICN

- **TRIAD: (Cheriton-** early work (2001)- new architecture, providing scalable content routing, caching, content transformation, load balancing, integrating naming, routing and transport connection setup

- *Source: J. Choi, J. Han, E.Cho, T.Kwon, and Y.Choi "A Survey on Content-Oriented Networking for Efficient Content Delivery"IEEE Communications Magazine, March 2011pp. 121- 127*

■ ICN (cont'd)

- Infrastructure providing in-network caching
- Content is distributed in a scalable, cost-efficient & secure manner
- Receiver-driven model – subscribe/get objects of interest
- Support for location transparency, mobility & intermittent connectivity
- Still need to support interactivity (A/V) and location oriented services (e.g. similar service as telnet)

- *Source: G. Pavlou, Information-Centric Networking: Overview, Current State and Key Challenges, <http://www.ee.ucl.ac.uk/~gpavlou/>, IEEE ISCC 2011 Keynote*



2. Content and Services Oriented Networking



- **ICN (cont'd)**
 - the principal paradigm is **not E2E** communication between hosts
 - high amount of content need efficient distribution
 - **information objects** as a **first-class abstraction**
 - **focusing on the properties of such objects** and receivers' interests to achieve efficient and reliable distribution of such objects
 - **In-network storage, multiparty communication** through replication, and interaction
 - **publish-subscribe** models generally available for all kinds of applications,
 - **without need of dedicated systems** such as peer-to-peer overlays and proprietary CDNs
 - *Source: D. Kutscher, B.Ahlgren, H.Karl, B. Ohlman, S.Oueslati I.Solis, Information-Centric Networking— Dagstuhl Seminar — 2011*



2. Content and Services Oriented Networking



■ CON

- Decoupling contents from hosts (or their locations) not at the application but at the network level
- Hope to solve or mitigate also other Internet problems (mobility, security).
- Free application/service developers from reinventing application-specific delivery mechanisms
- Scalable and efficient delivery of requested contents (e.g., by supporting multicast/ broadcast/anycast)
 - CON: dealing with *content objects*: *naming, locating/routing, deliver/disseminate, caching in-network*
 - CON ~ ICN~CCN
 - *Source: J. Choi, J. Han, E.Cho, T.Kwon, and Y.Choi "A Survey on Content-Oriented Networking for Efficient Content Delivery"IEEE Communications Magazine, March 2011pp. 121- 127*

■ CCN

- CCN treats content as a primitive – decoupling location from identity, security and access, and retrieving content by name
- New approaches to routing named content,
- derived from IP, one can achieve scalability, security and performance
 - *Source: Van Jacobson, D.K. Smetters, J.D. Thornton, M. F. Plass, NH. Briggs, R.L. Braynard, Networking Named Content, Palo Alto Research Center, Palo Alto, CA, October 2009*



2. Content and Services Oriented Networking



■ CAN-NAA

- Content awareness at network level and content oriented processing
- Network awareness at service application layer
- the content-oriented paradigm: *content-oriented, content centric, content-based, data-oriented, or data-centric network* are considered to be equivalent in that they focus not only on the communication party but the content or data itself
 - Source: K.Cho, J. Choi, D.Ko, T.Kwon, Y.Choi, *Content-Oriented Networking as a Future Internet*

■ However

- there is little common terminology between different ICN/CON/CCN, ...proposals
- no common framework → the focus is often on low-level mechanisms
- many studies “accentuate the differences between their design and others”
- they do not clarify enough the construction of the ICN assembly
 - Source: A.Ghods, T.Koponen, B.Raghavan, S.Shenker, A.Singla, J.Wilcox, *Information-Centric Networking: Seeing the Forest for the Trees*, <http://www.icsi.berkeley.edu/~barath/papers/icn-hotnets11.pdf>



2. Content and Services Oriented Networking



■ Content-oriented concepts

- CON node : **routing by content names**, not by (host) locators
 - *hosts Identification* is replaced by *content identification*
 - content file location - independent of its name
 - *content naming and routing – independent of location*
 - free from mobility and multi-homing problems

- **Publish/subscribe (P/S)** communication model
 - Essential in CON:
 - A content source announces (or *publishes*) a content file
 - An user requests (or *subscribes* to) the content file.
 - P/S
 - **decouples the content generation and consumption** in time and space
 - so contents are delivered efficiently and scalably (e.g., multicast/anycast)

 - *Source: J.Choi, Jinyoung Han, E.Cho, Ted Kwon, and Y.Choi, A Survey on Content-Oriented Networking for Efficient Content Delivery, IEEE Communications Magazine • March 2011*



2. Content and Services Oriented Networking



- Examples of recent CON projects
 - UCB **DONA** - Data-Oriented Network Architecture
 - 4WARD/SAIL **NetInf** - Network of Information
 - PSIRP/PURSUIT **PubSub** - Publish Subscribe Routing
 - Xerox PARC **CCN** - Content-Centric Networking
 - COMET **CMP** - Content Mediation Plane
 - **NDN** – Named Data Networking



2. Content and Services Oriented Networking



- **Content-oriented concepts (cont'd)**
 - **Content naming: Hierarchical; Flat; Attribute Naming**
 - **Hierarchical Naming (TRIAD, CCN, ..)**
 - hierarchical structure to name a content file
 - A content file is often named by an identifier like a web URL (e.g. /www.acme.com/main/logo.jpg)
 - → the naming mechanism similar to URL based applications/services, (lower deployment hurdle)
 - **Advantage:**
 - routing scalability (routing entries for contents might be aggregated)
 - **Limitation:**
 - if content files are replicated at multiple places, the degree of aggregation gets lower
 - components in a hierarchical name have semantics, which does not allow *persistent* naming
 - Persistence : once a content name is given, people would like to access the content file with the same name as long as possible.

CCN: Van Jacobson Diana K. Smetters James D. Thornton Michael F. Plass, Nicholas H. Briggs Rebecca L. Braynard, Networking Named Content, Palo Alto Research Center, Palo Alto, CA, October 2009



3. Content and Services Oriented Networking



- **Content-oriented concepts (cont'd)**
 - Content naming
 - Flat names (DONA, PSIRP)
 - flat and **self-certifying names** - by defining a content identifier as a cryptographic hash of a public key
 - Flatness (a name is a random looking series of bits with no semantics) → **persistence** and **uniqueness** are achieved.
 - **Limitation:**
 - flat naming → routing scalability problem (no possibility of aggregation)
 - flat names are not human-readable,--> additional “resolution” between (application-level) human-readable names and content names may be needed.
- *DONA: T. Koponen et al., “A Data-Oriented (and Beyond) Network Architecture,” SIGCOMM '07, 2007, pp. 181–92*
- *PSIRP : K. Visala et al., “An Inter-Domain Data-Oriented Routing Architecture,” ReArch '09: Proc. 2009 Wksp. Rearchitecting the internet, New York, NY, 2009, pp. 55–60.*



3. Content and Services Oriented Networking



- **Content-oriented concepts (cont'd)**
 - Content naming
 - *Attribute-Based Naming* — CBCB
 - Identifies contents with a set of **attribute-value pairs (AVPs)**.
 - A user specifies her interests with a conjunction and disjunction of AVPs -> a CON node can locate eligible contents by comparing the interest with advertised AVPs from content sources.
 - It can facilitate *in-network searching* (and routing), which is performed by external searching engines in the current Internet.
 - **Limitations**
 - An AVP may not be unique or well defined
 - The semantics of AVPs may be ambiguous
 - The number of possible AVPs can be very large
- *Source: CBCB : A.Carzaniga, M. J. Rutherford, A. L. Wolf, A Routing Scheme for Content-Based Networking, http://www.inf.usi.ch/carzaniga/papers/crw_infocom04.pdf*



2. Content and Services Oriented Networking



- **Content-oriented concepts (cont'd)**
- **Name based routing**
 - CON locate a content file based on its name → *name-based routing*
 - **Unstructured Routing**
 - Similar to IP routing : no structure to maintain routing tables
 - the routing advertisement (for contents) is mainly performed by flooding
 - Network prefixes are aggregatable similar to IP routing
 - **Structured Routing**
 - **Solutions: tree or distributed hash table (DHT) solutions**
 - **Tree-based routing scheme**
 - Routers form a hierarchical tree
 - each router maintains the routing information of all the contents published in its descendant routers
 - **Hierarchical Distributed Hash Tables**
 - The flatness of a DHT imposes an equal and scalable routing burden among routers.
 - If the number of contents is C , each router should have $\log(C)$ routing entries



2. Content and Services Oriented Networking



- **Content-oriented concepts (cont'd)**
- **MULTISOURCE DISSEMINATION**
- Current Internet solutions: IP Multicast, Overlays (P2P, ...)
- **CON solutions**
- **1:N Connectivity (multicast)**
 - CON accommodates 1:N connectivity naturally by the P/S paradigm in terms of content naming and group management
 - its link efficiency is similar to IP multicasting.
- **M:N connectivity**
 - Cases:
 - M instances of 1:N connectivity (e.g., videoconference).
 - M sources disseminate different parts of a content file to N recipients
 - Applications
 - Peer to peer (P2P)
 - multi-user online gaming (different but partially overlapping game data are transmitted to players).
- CON can efficiently disseminate contents at the network level by spatial decoupling of the P/S paradigm and content awareness at network nodes.
 - Current Internet: File distribution can be inefficient given that at P2P application layer
 - There is no or little network topology information
 - (note that Application Layer Traffic Optimisation - ALTO group at IETF try to improve the solutions)



2. Content and Services Oriented Networking



- **Content-oriented concepts (cont'd)**
- **MULTISOURCE DISSEMINATION (cont'd)**
- In CON, caching solution can efficiently disseminate a content
 - Disseminating a content file from **multiple sources** is **coupled with name-based routing**
 - To exploit multiple sources in disseminating the same content, each CON node may keep track of individual sources of the same content (CCN, DONA)
 - A CON node can seek to *retrieve different parts of the requested content in parallel from multiple sources* to expedite dissemination
 - However, the CON node should dynamically decide/adjust which part of the content file to receive from what source
 - depending on RTT
 - and traffic dynamics of the path to each source
- Issue: what routing information should be stored and advertised by each CON node for multiple sources of the same content ?
 - Idea: a CON node may not advertise all sources (by applying policies, e.g. to not advertise very far sources)
 - This is important design issue



2. Content and Services Oriented Networking



- **Content-oriented concepts (cont'd)**
- **IN-NETWORK CACHING**
 - It is a main feature of CON
- **Advantages for ISP:**
 - reduce the incoming traffic from neighbor ISPs (reduce the inter-domain traffic)
 - improve the delay/ throughput performance
 - contents closer to their users - similar to CDNs
 - attractive to content providers (CPs) since it can lower CAPEX for Content Servers
 - can offer CDN-like business to CPs
 - if a significant number of potential subscribers to the CPs are connected to the ISP
 - Caching policies efficiency improvement
 - *least recently used* (LRU), and *least frequently used* – LFU replacement policies at CON nodes are studied
 - coordination of multiple CON nodes in a distributed mode



2. Content and Services Oriented Networking



- **Content-oriented concepts (cont'd)**
- In the current Internet:
 - recent studies on *distributed caching* (caching points location)
 - Limitations given by IP style of working:
 - Only a single source (or cache) delivers the content file to a subscriber.
 - Limited topologies (e.g. tree) or places (e.g. point of presence) are taken into account.
- CON approach (open research issues):
 - multisource dissemination and general network settings - possible
 - signaling protocol among CON nodes to support distributed caching
 - e.g by extending an existing routing protocol
 - balance the frequency of replacing the files in cache and advertisement related signaling



3. Content and Services Oriented Networking



- **Example 1: Content Centric Networking**
- **Main source: Van Jacobson Diana K. Smetters James D. Thornton Michael F. Plass, Nicholas H. Briggs Rebecca L. Braynard, Networking Named Content, Palo Alto Research Center, Palo Alto, CA, October 2009**
- **CCN Concepts**
 - Current network **evolve mainly to content distribution and retrieval**
 - Traditional networking : connections based on hosts locations (need mapping *what* -> *where*).
 - CCN: Content treated as a primitive – *decoupling*
 - *location from identity, security and access,*
 - *retrieving content by name*
 - *Routing named content*, (derived from IP), allows, (*claimed by authors*), to achieve *scalability* security and performance



3. Content and Services Oriented Networking



CCN concepts (cont'd)

CCN proposes new "thin waist" of the Internet: IP → to chunks of named content

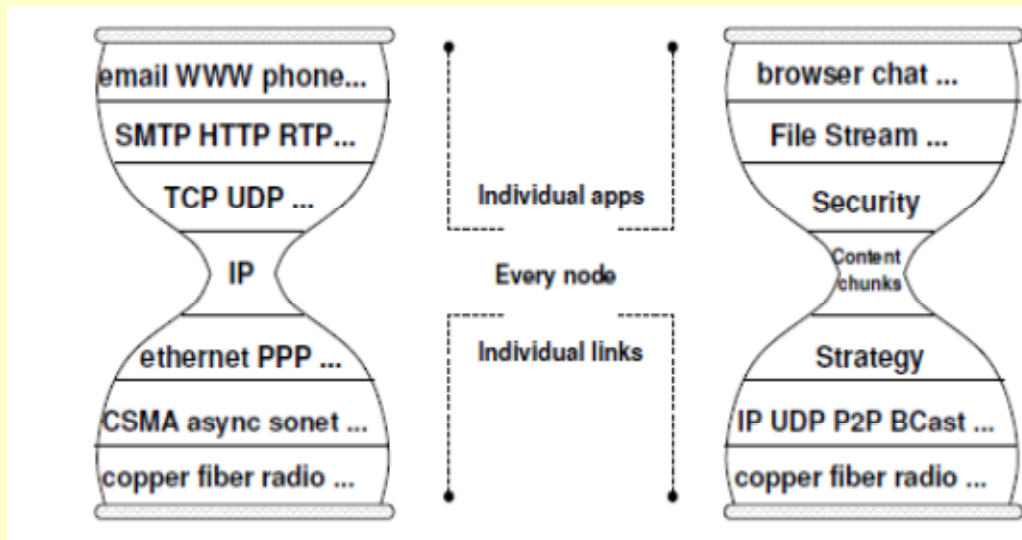

Traditional TCP/IP stack

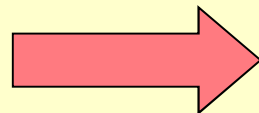

Original picture CCN

Application	Applications: browser chat, file stream:
	Security
	Content chunks
	Strategy
TCP, UDP, ...	P2P, .. UDP
IP	Intra-domain routing: OSPF, .. Inter-domain routing: BGP, ... (placed here to show their role)
Data link	Any Layer 2
Physical Layer (wireline, wireless)	Any PHY

Alternative view of CCN stack (if it runs on top of IP)

Source: Van Jacobson Diana K. Smetters James D. Thornton Michael F. Plass, Nicholas H. Briggs Rebecca L. Braynard, Networking Named Content, Palo Alto Research Center, Palo Alto, CA, October 2009

NexComm 2012 Conference, April 29-May 4, 2012 Chamonix, France



3. Content and Services Oriented Networking



- **CCN Concepts (cont'd)**
 - Most layers of the traditional stack have horizontal bilateral agreements/protocols (Node to node, end to end)
 - Network layer : the only one requiring universal agreement
 - **Why IP's success ?:**
 - simple (long time accepted to be the thin 'waist' of the stack)
 - flexible (dynamic routing)
 - Any L4 on top of it
 - Any L2 under it: Low demand from L2: stateless, unreliable, unordered, best-effort delivery
 - **CCN's "network layer" is claimed to be similar to IP**
 - it makes fewer demands on L2,
 - (+): CCN *can run on top of anything*, including IP itself



3. Content and Services Oriented Networking



■ **CCN Concepts (cont'd)**

- CCN specific features- different from IP
 - **Strategy and security: new layers**
 - can use multiple simultaneous connectivity (e.g., Ethernet, 3G, 802.11, 802.16, etc.) due to its simpler relationship with layer 2.
 - **Strategy layer**
 - *makes dynamic optimization* choices - to best exploit multiple connectivity under changing conditions
 - **Security Layer**
 - *CCN secures the content objects* rather than the connections over which it travels (*this is to be discussed more..*)
 - avoiding many of the host-based vulnerabilities of current IP networking



3. Content and Services Oriented Networking



- **CCN Concepts (cont'd)**
- **CCN Naming**
 - CCN names :opaque, binary objects composed of an (explicitly specified) number of components
 - Hierarchical structure of names => the above prefix match is equivalent to
 - *Data_Packet* is in the *name subtree* specified by the *Interest_Packet*
 - Similarity with hierarchical structure of IP addresses ((net, subnet, ..)
 - Name prefixes can be context dependent
 - e.g. "This_building/this_room"

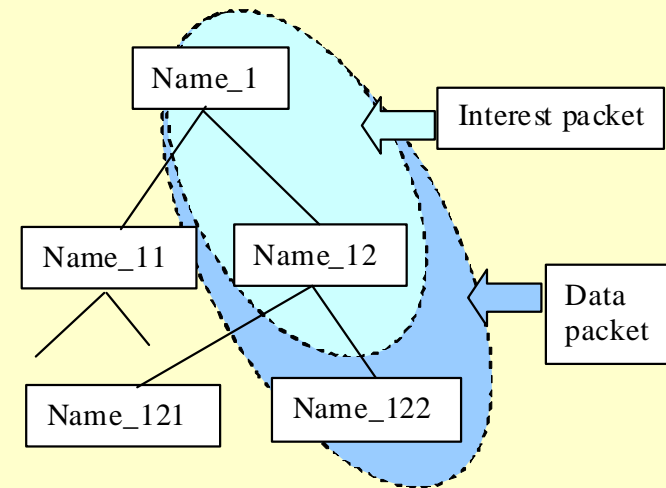

Interest (Name_1/Name_12)

Data (Name_1/Name_12/Name_122)



3. Content and Services Oriented Networking



- **CCN Concepts (cont'd)**
- **CCN high level description**
 - The content producers advertise their content objects
 - The nodes store the interfaces from where content can be reachable
 - Some “forwarding tables” are filled
 - The consumers *broadcast* their **interest** for some **content**
 - Any node hearing the **Interest** and having the required content can respond with **Data packet**
 - *Data* are returned as a response to an interest only and consumes this *interest* (1-to- 1 relationship Interest-Data)
 - Multiple nodes interested in the same content may share the Data Packets: CCN is naturally **multicast enabled**
 - **Content characterisation:**
 - Data ‘satisfies’ an Interest if the *ContentName* in the *Interest Packet* is a prefix of the *ContentName* in the *DataPacket*



CONTENTS



1. Introduction: Future Internet -Trends and Challenges
2. Content and Services Oriented Networking
3.  **Content Oriented Routing and Forwarding**
4. Comparison of Solutions
5. ALICANTE Project Solutions
6. Conclusions



3. Content Oriented Routing and Forwarding



- **Summary**
- **Name based routing**
- CON locate a content file based on its name = *name-based routing*

- **Unstructured Routing**
- Similar to IP routing : no structure to maintain routing tables
- the routing advertisement (for contents) is mainly performed based on flooding.
 - **Example: CCN**; it has IP compatibility to a certain degree.
 - CCN might be deployed incrementally with current IP networking.
 - CCN replaces *network prefixes* (in IP routing) with *content identifiers*,
 - (modification of IP routing protocols may not be significant).

- Network prefixes can be aggregated in IP routing ~ so are hierarchical content identifiers in CCN routing.
- **Limitation:**
 - If content file is increasingly replicated or moved, the level of aggregation is lower.
 - High control traffic overhead (announcement messages if a content file is created, replicated, or deleted)



3. Content Oriented Routing and Forwarding



- **Content-oriented concepts (cont'd)**
 - **Name based routing**
 - ***Structured Routing***
 - **Solutions: *tree* and a *distributed hash table* (DHT).**

- **Tree-based routing scheme (E.g. DONA)**
 - Routers form a hierarchical tree
 - each router maintains the routing info of all the contents published in its descendant routers.
 - When a content file is newly published, replicated, or removed, the announcement will be propagated up along the tree until it encounters a router with the corresponding routing entry.
 - **Limitation:**
 - increasing routing burden for high level routers
 - the root router should have the routing information of all the contents in the network.
 - **flat content names → scalability problem**



3. Content Oriented Routing and Forwarding



- **Content-oriented concepts (cont'd)**
 - **Name based routing**

 - **Structured Routing (cont'd)**
 - **Hierarchical Distributed Hash Tables (PSIRP project)**

 - DHT is flat → an equal and scalable routing burden among routers
 - If the number of contents is C , each router should have $\log(C)$ routing entries

 - **Limitations:**
 - the DHT is constructed by random and uniform placement of routers, and → longer paths than a tree (the tree can exploit the information of network topology)

 - DHT is flat -> often requires forwarding traffic in a direction that violates the provider-customer relation among ISPs



3. Content Oriented Routing and Forwarding



- **Content-oriented concepts (cont'd)**
 - **Comparison**
 - **Source:**J.Choi, Jinyoung Han, E.Cho, Ted Kwon, and Y.Choi,A Survey on Content-Oriented Networking for Efficient Content Delivery, IEEE Communications Magazine • March 2011

	Naming	Naming advantages	Routing structure	Routing scalability	Control overheads
CCN	Hierarchical	Aggregatable, IP compatible	Unstructured	N (best) C (worst)	High
DONA	Flat	Persistent	Structured (tree)	C	Low
PSIRP	Flat	Persistent	Structured (hierarchical DHT)	$\log C$	Low
TRIAD	Hierarchical	Aggregatable, IP compatible	Unstructured	N	High
CBCB	(attribute, value) pairs	In-network searching	Source-based multicast tree	2^A	High

- *N , C , and A are the numbers of publisher nodes, contents, and attributes in the entire network, respectively*



3. Content Oriented Routing and Forwarding



- **Example 1: CCN Routing and Forwarding**
- **CCN packets**

CCN Forwarding Engine Model (See Reference)

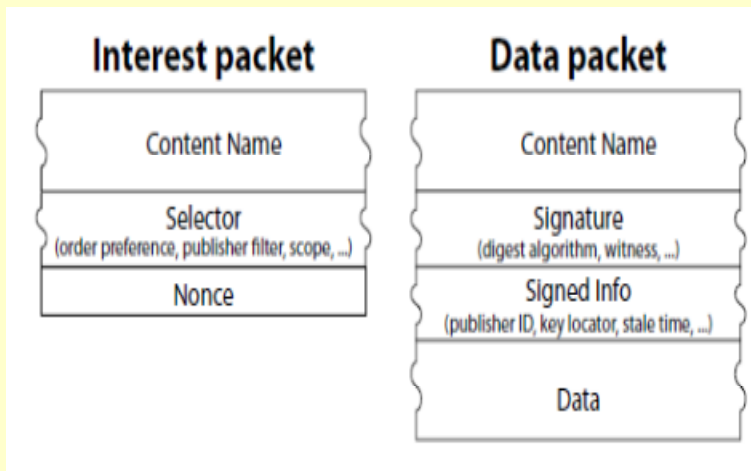

CCN Packet types

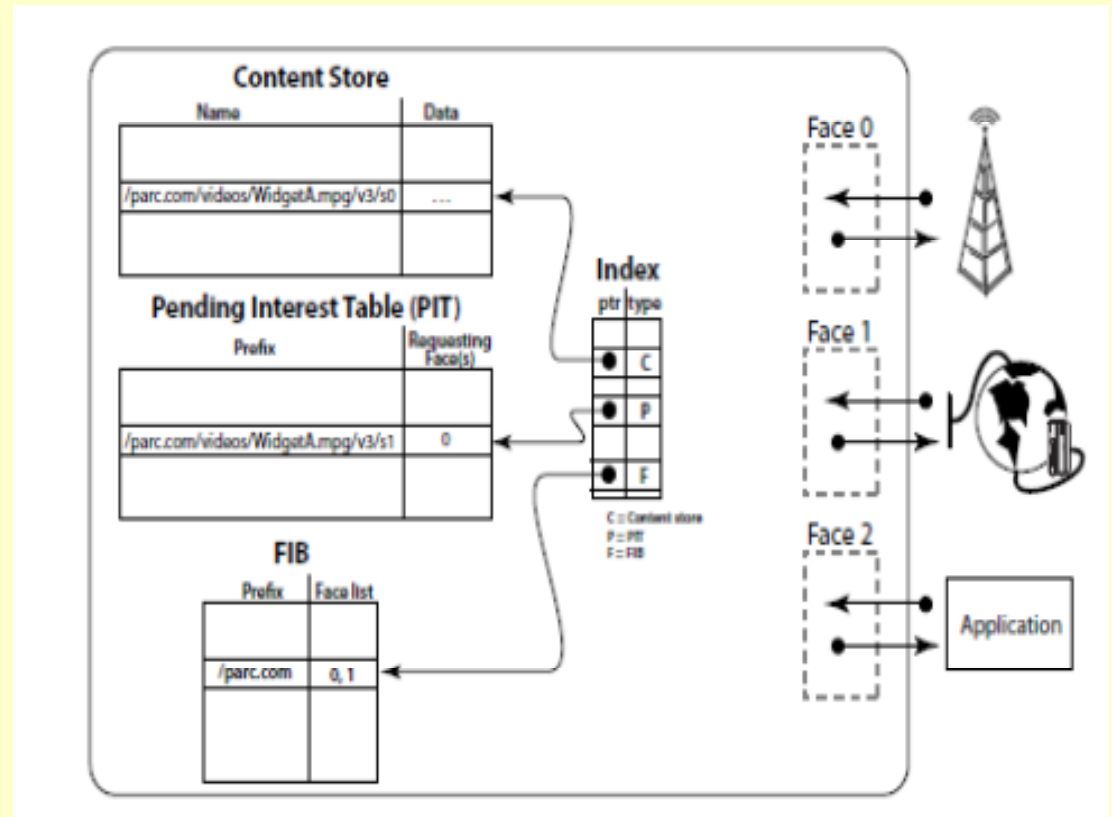

Source: Van Jacobson Diana K. Smetters James D. Thornton Michael F. Plass, Nicholas H. Briggs Rebecca L. Braynard, Networking Named Content, Palo Alto Research Center, Palo Alto, CA, October 2009



3. Content Oriented Routing and Forwarding



- **CCN node model**
- **CCN Forwarding engine**
 - FIB (Forwarding Information Base)
 - CS (Content Store – i.e. buffer memory)
 - PIT (Pending Interest Table)

- **FIB**
 - used to forward an *Interest Packets* towards potential (sources)
 - Similar to IP FIB
 - But admits several I/Fs
 - multiple sources that can act in parallel
 - CCN is not limited to the spanning tree as in IP routing

- **CS**
 - Same as buffer memory in IP router
 - stores the *Data Packets* to be used in the future by other recipients (different w.r.t. IP router which forgets a packet after it has been forwarded)
 - It has a different replacement policy
 - Allows “caching” at every node – depending on its capabilities
 - Content delivery performance is increased due to caching



3. Content Oriented Routing and Forwarding



- **CCN Node Model (cont'd)**
- **CCN Forwarding engine**

- **Pending Interest Table (PIT)**
 - Stores the pending requests for content, i.e.
 - It **keeps track of Interest-Packets** forwarded upstream toward content source(s) so that returned Data can be sent downstream to its requester(s)
 - In CCN **the routes are computed for Interest Packets packets only**, (when they propagates upstream towards the data sources)
 - Each unsolved Interest Packet is stored in PIT → Data Packets will be forwarded on the reverse (towards the requester(s) path when they come)
 - **Basic operation at a CCN node**
 - **similar to IP node (router) when performing forwarding phase**
 - If a Packet arrives on an I/F (*Interest* or *Data*)
 - (note that in original CCN documents these are named *faces* – as to emphasize their logical roles – an I/F can be in the same machine towards an application
 - Longest match look-up is performed based on its *ContentName*
 - Appropriate actions are done based on the result



3. Content Oriented Routing and Forwarding



- **CCN node model (cont'd)**
- **Basic operation at a CCN node**

- **Interest Packet arrives**
 - Longest match lookup is done based on its *ContentName*

 - **Priorities of the search: CS, PIT, FIB**

 - **If** there is a content in the CS matching the *Interest Packet*
 - Then a *Data Packet* is sent in the reverse direction on the I/F the *Interest Packet* arrived
 - **Discard the *Interest Packet*** (the request has been solved)

 - **Otherwise:** If there is an exact match to PIT
 - then a new I/F is added to the pending list
 - *Interest Packet* is discarded (similar to IGMP registration protocol in multicast)

 - **Otherwise:** If a FIB matching is found
 - then the request (*Interest Packet*) is sent upstream towards the data source(s) on all I/Fs except the input I/F

 - **If no match** for *Interest Packet* then discard it



3. Content Oriented Routing and Forwarding



- **CCN node model (cont'd)**
- **Basic operation at a CCN node**

- **Data packet arrives**
 - Data Packets generally follows the route back conforming the PIT information

 - **Longest-match lookup** is done at *Data Packet* arrival on its Content Name
 - CS match => Data Packet is a duplicate, discard
 - PIT match (there can be more that one) => then it is performed:
 - Data validation (security)
 - Data are added to the CS (caching)
 - Data are sent towards the pending entities (list in PIT)
 - The PIT- corresponding pending requests are solved (erased)

 - In CCN each new packet of data is sent only after a new interest is expressed
 - This approach is similar to TCP ACKs(giving a new window to the transmitter) + Data packets
 - **Senders are stateless**, so retransmission if necessary is requested by the application (the strategy level has the task to determine the policies)
 - CCN has in such a way a flow control mechanism



3. Content Oriented Routing and Forwarding



■ **CCN Routing**

■ **Routing task: to construct FIBs**

■ **General characteristics**

- Routing between CCN nodes can occur over *unmodified* Link State Interior Gateway Protocols IGP (OSPF, IS-IS, ..)
- Consequence: possible incremental CCN deployment
- No spanning trees constraints are existent
- Loops are avoided
- Multiple paths are possible

■ **Intra-Domain Routing**

- CCN Content Names can be aggregated -> gives the possibility to apply “longest match” method in forwarding
- How to distribute *Content Names* among routers?
 - OSPF, IS-IS can distribute content prefixes in TLV (Type Length Value) form
- **Conclusion: CCN Interest/Data forwarding can be built on top of existing IP infrastructure without any modification to the routers.**



3. Content Oriented Routing and Forwarding



- **CCN Routing(cont'd)**
- **Intra-domain Routing**
 - CCN's forwarding model is a superset of the IP model → any routing scheme that works for IP works well for CCN
 - CCN:
 - multi-source, multi-destination avoid looping
 - same semantics relevant to routing (hierarchical name aggregation with longest-match lookup)
 - The essential of many routing protocols transportation of routing messages is similar to CCN's information-oriented guided-diffusion flooding model
 - they function in the pre-topology phase of networking
 - where peer identities and locations are not known
 - **LS IGPs – two orthogonal functions**
 - discover and describe their local connectivity
 - (links/'adjacencies')
 - describe directly connected resources
 - (what entities are reachable -'prefix announcements')



3. Content Oriented Routing and Forwarding



- **CCN Routing(cont'd)**
- **Intra-domain Routing IP forwarding \approx CCN forwarding**
 - use prefix-based longest match lookups
 - and use them for the same reason—hierarchical aggregation to find local neighbor(s) 'closer' to the identifier matched.
- Routing messages distribution is similar to IP
 - IS-IS and OSPF can describe directly connected resources via a general TLV ('type label value') scheme **that is suitable for distributing CCN content prefixes.**
 - unrecognized types are ignored \rightarrow content routers, implementing the full CCN forwarding model, can be attached to an existing IS-IS or OSPF network with no modifications to the network or its routers.
 - **The content routers**
 - learn the physical network topology and announce their place in that topology via the adjacency protocol
 - and flood their prefixes in prefix announcements using a CCN TLV



3. Content Oriented Routing and Forwarding



- **CCN Routing (cont'd)**
- **Intra-domain Routing**
 - **Example (see the figure in the next slide)**
 - Media repository next to B is announcing (via a CCN broadcast in a local network management namespace) that it can serve Interests matching the prefix /name1/name11/name111
 - **A routing application on B hears this announcement**
 - (since it has expressed interest in the namespace where such announcements are made)
 - installs a local CCN FIB entry for the prefix pointing at the I/F where it heard the announcement
 - And packages the prefix into IGP LSA which is flooded to all nodes
 - When the routing application on A, initially gets this LSA
 - It creates a CCN I/F to B
 - adds a prefix entry for "/name1/name11/name111" via that I/F to the local CCN FIB
 - Similar behavior of CCN node C
 - An interest in name1/name11/name111/name1111 expressed by a client adjacent to A will be forwarded to both B and C, who each forward it to their adjacent repository.



3. Content Oriented Routing and Forwarding



- **CCN Routing (cont'd)**
 - **Intra-domain Routing**
 - Example

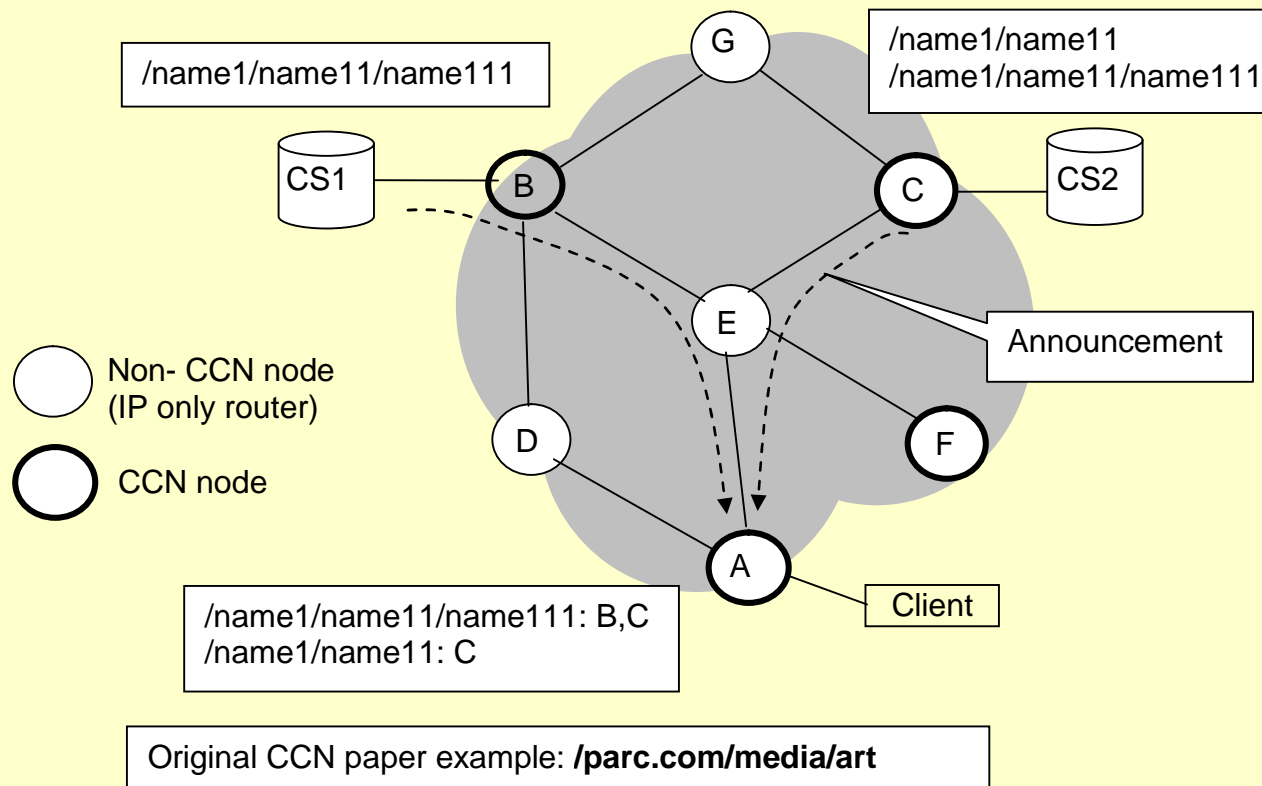



3. Content Oriented Routing and Forwarding



- **CCN Routing (cont'd)**
 - **Intra-domain Routing**
 - CCN
 - dynamically constructs topologies
 - close to optimal for both bandwidth and delay
 - (i.e., data goes only where there is interest, over the shortest path, and at most one copy of any piece of data goes over any link).
 - The delivery topology is non-optimal if non-CCN routers exist (e.g node E)
 - a client adjacent to F interested in the same content will get a second copy of the content from B or C
 - If E is CCN then it can cache the content
 - In this way distribution will be optimised



3. Content Oriented Routing and Forwarding



■ **CCN Routing (cont'd)**

■ **Intra-domain Routing**

■ **Security issues**

- In the model above IGP LSA's are used as a transport for normal CCN messages which have full CCN content authentication, protection and policy annotation.
 - Consequence: even though the IGP is not secure, the communication between CCN-capable nodes is secure.
- If all the nodes are evolved to being CCN-capable, the IGP topology infrastructure is automatically secured
- The security of the externally originated prefix announcements is a function of the announcing protocol.
- CCN content prefixes, (e.g. those announced by the media servers), are secured by CCN
- IP prefixes announced from other IGPs or BGP are untrusted.



3. Content Oriented Routing and Forwarding



■ CCN Routing (cont'd)

■ Intra-domain Semantic differences IP/CCN

■ Differences IP :CCN

■ Multiple announcements of the same prefix:

- An IP prefix announcement from some IGP router says “all the hosts with this prefix can be reached via me”.
- A CCN router says “some of the content with this prefix can be reached via me”.

■ In the case of multiple announcements of the same prefix.

- IP : any node sends all matching traffic to *exactly one* of the announcers.
- CCN: all nodes send all matching interests to all of the announcers.

■ IP

- Cannot detect loops at the content level → need to construct loop-free forwarding topologies, i.e., *a sink tree rooted at the destination*
- An IP FIB has only one slot for ‘outgoing interface’.
- All hosts associated with a prefix are reachable via the node announcing a prefix (all traffic matching the prefix will be sent to that node).



3. Content Oriented Routing and Forwarding



- **CCN Routing (cont'd)**
 - **Intra-domain Semantic differences IP/CCN**
 - **Differences IP :CCN**
 - CCN
 - The packets cannot loop
 - so, the CCN FIBs can be set up to forward *Interests Packets* to all the nodes that announce the prefix.
 - Important for implementation:
 - This semantic difference can be accommodated without changing the IGP
 - because it is an implementation change, not a protocol change
 - IP has to compute a spanning tree from prefix announcements
 - CCN does not do that
 - Note that this computation is done where the information is used, not where it is produced, so both protocols receive complete information.



3. Content Oriented Routing and Forwarding



- **CCN Routing (cont'd)**
 - **Inter-domain Routing**
 - Objective of content distribution requirement:
 - to reduce the distance between content servers/caches and users
 - Inter-domain traffic also should be minimized
 - Customers directly connected to their ISP
 - Can learn about the ISP's content router via a service discovery protocol running over the customer-ISP peering link(s).
 - these options do not require any inter-domain distribution of content prefixes.
 - **Problem** : domains having CCN routers separated by ISP(s) that do not have such routers: there is a gap that should be solved
 - **Solution: integrating domain-level content prefixes into BGP**
 - BGP has the equivalent of the IGP TLV mechanism.
 - It is possible to learn
 - which domains can serve *Interests* in some prefix and
 - what is the closest CCN-capable domain on the paths towards those domains.
 - **Conclusion: possible to deploy CCN in the existing BGP infrastructure**



3. Content Oriented Routing and Forwarding



- **Example 2: DONA Routing and Forwarding**
- *Source: T. Koponen et al., "A Data-Oriented (and Beyond) Network Architecture," SIGCOMM '07, 2007, pp. 181–92*
- DONA replaces the DNS based name space with self-certifying flat labels
 - Derived from cryptographic public keys
- Names are expressed as $\langle P, L \rangle$
 - P = hash of a principal public key owning the data
 - L = label
 - DONA uses
 - an IP header extension mechanism to add DONA header to IP header
 - Separate Resolution Handlers (RH) to resolve $\langle P, L \rangle$ into topological routes
 - Data – transmitted as triplets (data, public key, signature)
 - A recipient can verify the data authenticity after receiving the data item



3. Content Oriented Routing and Forwarding



- **Example 2: DONA Routing and Forwarding**
- **DONA starting points**
 - ICN general paradigm : “*where*” (*location*) → “*what*” (*content/ information*)
 - **User relevant issues**
 - **Persistence:** data/ service name to be valid as long as the data or service is available.
 - **Availability:** access to data and service should be reliable and have low-latency.
 - **Authenticity:** data came from the appropriate source, rather than from a non-guaranteed/unknown one
- **Current situation:**

	Mechanism	Problems
Persistence	DNS, HTTP redirect	Do not work as it is, if data move across domains
Availability	CDNs, P2P	Are based on application-specific and ad hoc mechanisms
Authenticity	IPsec, PKI, TLS	Basically secures the transport channel, and not the content



3. Content Oriented Routing and Forwarding



- **Example 2: DONA (cont'd)**
 - **DONA proposal:** replaces DNS
 - names with flat, self-certifying names
 - name resolution with a **name-based *anycast* primitive**
 - **DONA claims to achieve**
 - *Persistence*: Flat names-> remain invariant
 - *Authenticity*: Self-certifying names-> enable easy authentication
 - *Availability*: Name resolution-> Route-by-name paradigm (*anycast* primitive)
 - **DONA Naming**
 - Naming organized around ***principals***
 - Each principal is associated with a public-private key pair, and each datum or service or any other named entity is associated with a principal



3. Content Oriented Routing and Forwarding



- **Example 2: DONA (cont)**
 - **Names are flat and have the form P:L**
 - *P* is the cryptographic hash of the principal's public key
 - *L* is a label chosen by the principal, who ensures that these names are unique
 - Naming granularity is left up to principals
 - a principal might choose to just name her web site, or name her web site and each page within it, or name at a finer granularity
- Principals own their data.
 - A piece of data comes with the principal's public key and the principal's signature of the data.
 - **<data, public key, signature>**
 - A client receiving a piece of data with the *name P:L*, can verify the data did come from the principal by
 - Checking that the public key is hashed into P
 - Validating that the signature corresponds to the public key



3. Content Oriented Routing and Forwarding



- **Example 2: DONA (cont'd)**
- **DONA Naming**
- **Problem: how to resolve flat names into the appropriate location**
 - ***DONA: route-by-name paradigm for name resolution.***
 - Resolution infrastructure consists of **Resolution handlers (RH)**
 - Each domain will have one logical RH.
- Name resolution – achieved by defining two basic primitives:
 - **REGISTER(P:L) and FIND(P:L)**
 - *REGISTER* messages set up the state necessary for the RHs to route effectively the FINDs
 - i.e. add P:L to registration table and forward REGISTER to parents and peers)
 - *FIND(P:L)* locate the object named P:L
 - RH will send FIND to next-hop RH if P:L in table; otherwise, send to parent RH
- **After requesting P:L, a client receives:**
 - <data, public key, signature>
 - Client checks:
 - 1) hash(public key) = P
 - 2) decrypt(public key, signature) = hash(data)



3. Content Oriented Routing and Forwarding



- **Example 2: DONA (cont'd)**

- **DONA REGISTER** state establishment
 - Any machine authorized to serve a datum or service with name P:L sends a REGISTER(P:L) command to its first-hop RH

 - RH maintains a registration table mapping a name *to both a new-hop RH and the distance to the copy (in some metric)*

 - REGISTERS are forwarded according to interdomain policies:
 - REGs from customers (child) to both peers and providers
 - REGs from peers optionally to providers/peers

- **Forwarding FIND(P:L)**
- FIND(P:L) arrives to a RH:
 - Existent entry in the registration table → FIND is sent to the next-hop RH
 - Non-existent entry in RT → the RH forwards the FIND towards to its provider (parent)
 - RH uses its local selection policy if multiple equal choices

- **Example 2: DONA (cont'd)**
 - The figure shows:
 - Registration state (solid arrows) in RHs after copies have registered themselves to RHs
 - RHs will route client-issued FIND (dashed arrow) to a nearby copy.

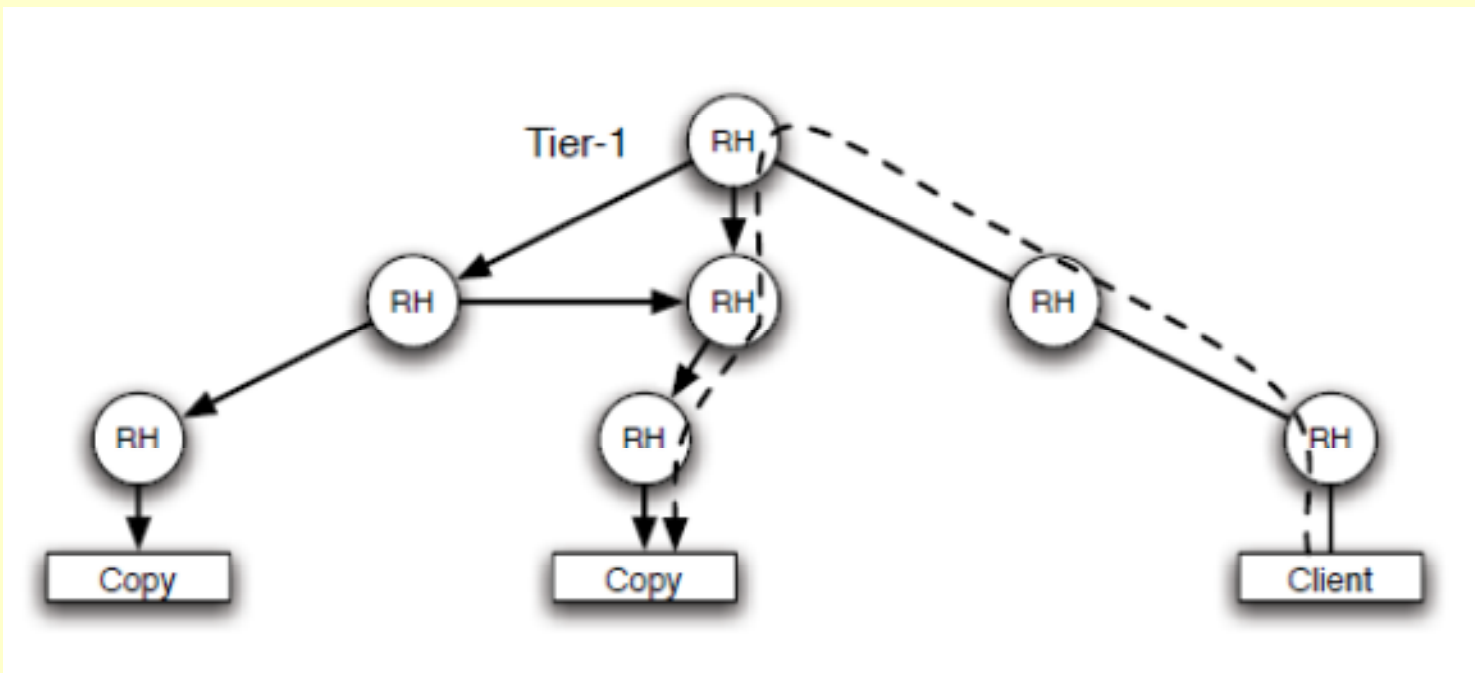

Source: T. Koponen et al., "A Data-Oriented (and Beyond) Network Architecture," SIGCOMM '07, 2007



3. Content Oriented Routing and Forwarding



- **Example 2: DONA (cont'd)**

- **DONA Challenges and solutions proposed by the authors**
 - *Security*: Private key can get compromised -> Need a Key revocation mechanism
 - *Usability*: Flat names are hard to remember by humans -> Need an external mapping mechanism
 - *Scalability*: Huge flat name space -> Need to make them more shortly...(local address)

- **DONA Name-based Anycast**
 - **Server Selection**
 - Each server/datacenter (authorized by a principal P) to host a service or datum named P:L simply registers P:L at their local RH.
 - DONA routes any FIND(P:L) to the closest such server



3. Content Oriented Routing and Forwarding



- **Example 2: DONA (cont)**

- **Mobility and Multihoming**
 - **A roaming host**
 - first unregister from one location and
 - then re-register at its new location.
 - Subsequent FINDs will be routed to the new location (after registrations have installed the necessary state).

 - **A multihomed host**
 - registers with each local RH

 - A multihomed domain forwards its REGISTERs to each provider.
 - So, FINDs, and thus the resulting data connections, to make use of multiple paths



3. Content Oriented Routing and Forwarding



- **Example 2: DONA (cont'd)**
- **DONA Multicast**
 - **Anycast primitive** provides the tree discovery function
 - allows a domain's BR that has local members in a multicast group G to discover and establish connectivity with other domains that have members in the group.
 - To **transmit a multicast packet** destined for a particular group P:G,
 - the sender's BR issues a FIND packet to locate a nearby domain that belongs to the group
 - and forwards the packet to that domain's BR, which in turn initiates the packet's dissemination.
 - Extension possible: anycast primitive provides support for a range of discovery-like tasks
 - Authors : "DONA is a better naming foundation than the current DNS system".



3. Content Oriented Routing and Forwarding



- **Example 2: DONA (cont'd)**

- **DONA Caching**
 - **Caching and routing are related – in terms of overall system efficiency**
 - RH first populates its cache
 - by changing the source IP address of an incoming FIND packet to be its own before forwarding the FIND to the next-hop RH.

 - When a (FIND arrives)& (cache hit),
 - The RH responds to the FIND's source IP address, returning appropriate transport response
 - Which then will proceed into a standard application-level exchange

 - If the RH does not understand the transport or application-level protocol (port in the transport header) for a particular FIND, it does not provide caching for that request.



3. Content Oriented Routing and Forwarding



- **Example 2: DONA (cont'd)**

- DONA – Improving Delivery
- Misbehaving and Overloaded Servers – (re-routing)
 - Usually RHs route FINDs to nearby copies of the data

 - There may exist misbehaving servers in a way that is not visible to the RHs but which deprives a client of a valid copy of data.

 - DONA allows the client to ask that its FIND be routed to a different server.

- Solutions for delivery improvements
 - Amend the REGISTER to keep track of the number of servers below a particular RH
 - Amend the FIND to allow the client to request access to the k'th closest server, rather than the closest one.
 - Allow overloaded servers to indicate this, so the RHs can then re-direct excess load to other servers.



3. Content Oriented Routing and Forwarding



- **Example 2: DONA (cont'd)**

- **DONA – Scalability and Implementation Issues**
 - Challenges
 - RH only keep routing state for data lying below or equal to it in the AS hierarchy
 - **Hard requirement for Tier-1 providers: RHs must keep everything in their registration tables**

- **Source: DONA documents**
 - Registration processing requirement for a single Tier-1 ISP:
 - 10^{11} names (2005) , 42 bytes per entry (40 for the name and 2 for a new-hop RH) = Routing table 4TB
 - Average registration lifetime 2 weeks = 83000 registration/s a Tier-1RH must handle (initial estimate)
 - **Forwarding requirements**
 - 20000 FINDs/s per every Gbit/s worth of traffic (by statistic of the experiment in 2005)



3. Content Oriented Routing and Forwarding



- **Example 2: DONA (cont'd)**

- **DONA – Scalability and Implementation Issues**
 - Hardware requirements
 - Each of these registrations involves
 - expensive cryptographic operations: using 40 CPUs running at 3 GHz could handle
 - However, if AS trusts its peering ASes to have done the crypto checks, then this load could be reduced

- **Store routing table: (FINDs can be processed either from RAM or from disk)**
 - In RAM: 500 PCs with 8GBs of RAM, or
 - On Disk: 50 disks per every 1 Gbit/s worth of traffic
 - The mix and (physical) distribution of RAM and disk depends on aggregate load and other factors (cache hit rate)



3. Content Oriented Routing and Forwarding



- **Example 2: DONA (cont'd)**
- **Conclusions on architectural impact**
 - Today applications : oriented on hosts, addresses, bytes (Socket API)
 - DONA: can use an API based on the FIND and REGISTER primitives
 - DONA- name orientation
 - Advantages: persistence, authentication, availability
 - Enable application protocols to be oriented around application objects
 - Higher level of abstraction in the API shield application from low-level communication details
 - Relationship DONA-Publish/Subscribe
 - DONA data-oriented API is semantically similar to a P/S interface
 - **REGISTER = publish; FIND = subscribe**
 - Pub/Sub decouples the application end-points in space, time, and synchronization and is used in many contexts
 - The universality of such and interface raises the possibility for new pub/sub-based



3. Content Oriented Routing and Forwarding



- **Example 3: PSIRP (Publish Subscribe Internet Routing Paradigm) project**
 - Continued with PURSUIT projects (extended range of PSIRP)
 - *Source: www.psirp.org*
 - **Communication model summary**
 - **PSIRP defines a Rendezvous system** – which binds associated *publications* and *subscriptions* within the *information network* and properly routes data amongst the corresponding nodes.
 - **Rendezvous** is accomplished through specialized functions operating between physical network devices known as *rendezvous points* (RPs),
 - RPs are viewed as being either fixed or non-fixed indirection points for network communications.
 - Collection of network RPs = PSIRP *rendezvous system*, responsible for associating data subscribers and publishers to some scope implementing the PSIRP design principle
 - **Rendezvous** : crucial in providing a control plane for connecting publishers and subscribers in a policy compliant fashion both within and between administrative domains



3. Content Oriented Routing and Forwarding



- **Example 3:PSIRP (Publish Subscribe Internet Routing Paradigm) project**
 - *Source: www.psirp.org*
 - **Communication model summary**
 - **Rendezvous system** binds associated publications and subscriptions within the information network and properly routes data amongst the corresponding nodes.

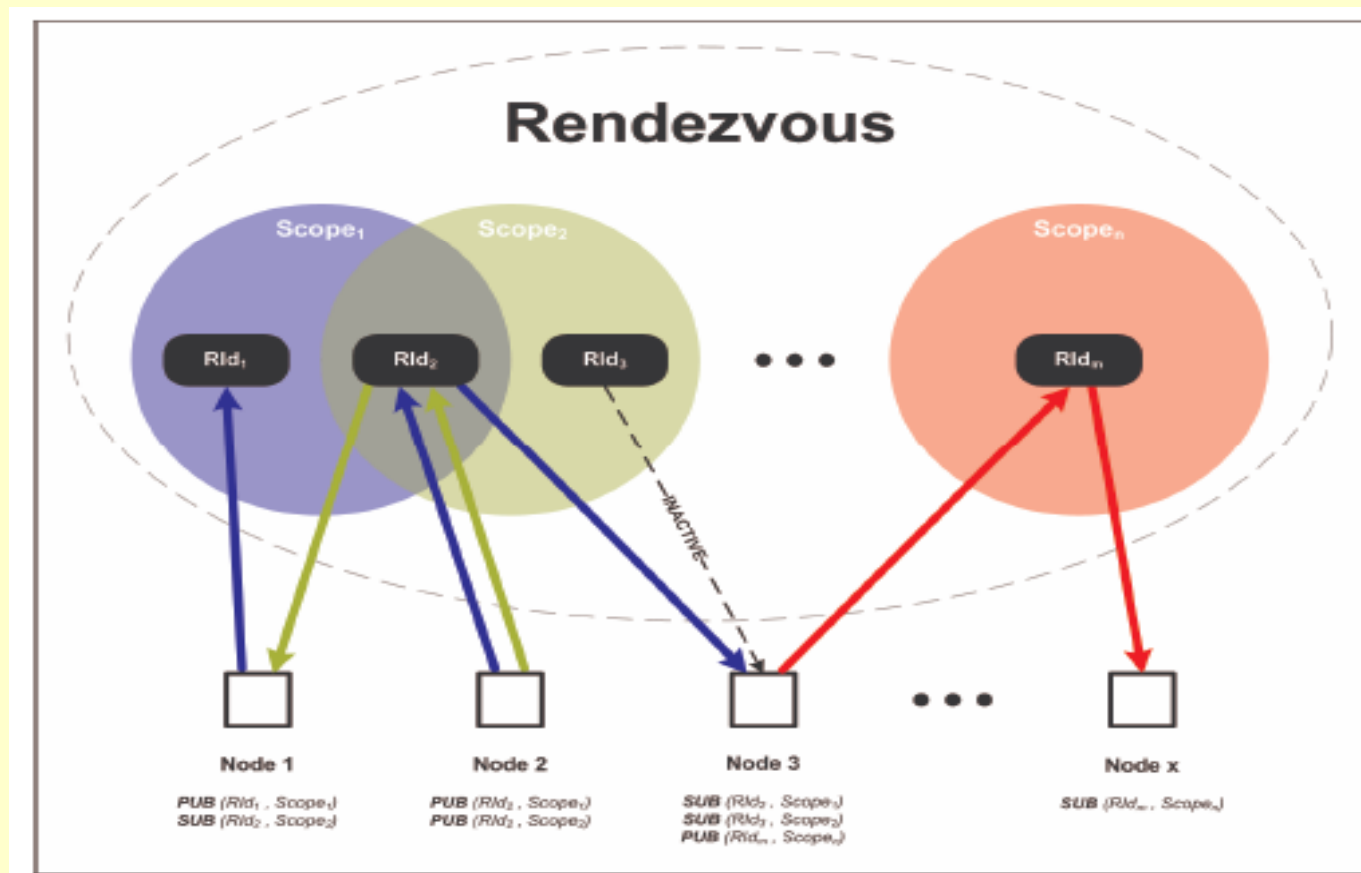

NexComm 2012 Conference, April 29-May 4, 2012 Chamonix, France



3. Content Oriented Routing and Forwarding



- **Example 3:PSIRP project (cont'd)**
 - Example:
 - **Node1**
 - publishes within scope1 to Rendezvous identifier RId1 which has no subscribers,
 - and subscribes to RId2 within scope2.
 - **Node2**
 - publishes using RId2 within both scope1 and scope2,
 - with Node3 and Node1 subscribing, respectively
 - **Node3** is subscribed to RId2 within scope1, and RId3 within scope2 (which has no publishers), and publishes to RIdm using scopen
 - **Node x** is subscribed to RIdm within scope n.



3. Content Oriented Routing and Forwarding



- **Example 3: PSIRP project (cont'd)**
- **Publish Subscribe Internet Routing Paradigm**
 - *Source:* www.psirp.org
 - Architecture: Rendezvous, Routing and Forwarding functionalities

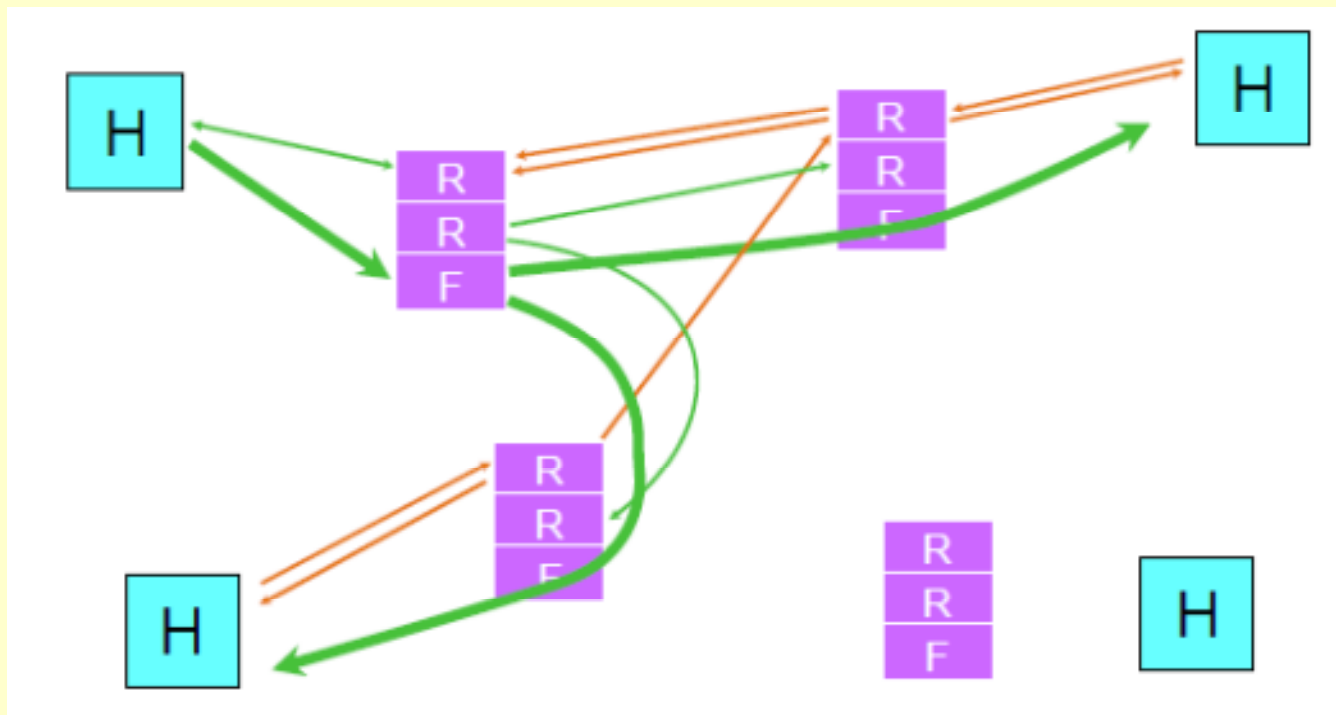



3. Content Oriented Routing and Forwarding



- **Example 4: Content-Aware Network**
- *Source: A. Carzaniga, M. J. Rutherford, A. L. Wolf, A Routing Scheme for Content-Based Networking, http://www.inf.usi.ch/carzaniga/papers/crw_infocom04.pdf*
- Content-based communication service example: datagram, connectionless service, through a *content-based network*
- content-based network as an overlay point-to-point network.
- **Routing in a content-based network**
 - synthesizing distribution paths throughout the network
 - forwarding : determining at each router the set of next-hop destinations of a message
- Solution: ***combined broadcast and content-based (CBCB)*** routing scheme.
 - **Content-based layer over a traditional broadcast layer**
 - broadcast layer handles each message as a broadcast message
 - content-based layer prunes the broadcast distribution paths, limiting the propagation of each message to only those nodes that advertised predicates matching the message

- **Example 4: Content-Aware Network (cont'd)**
- Network Overlay and High-Level Routing Scheme

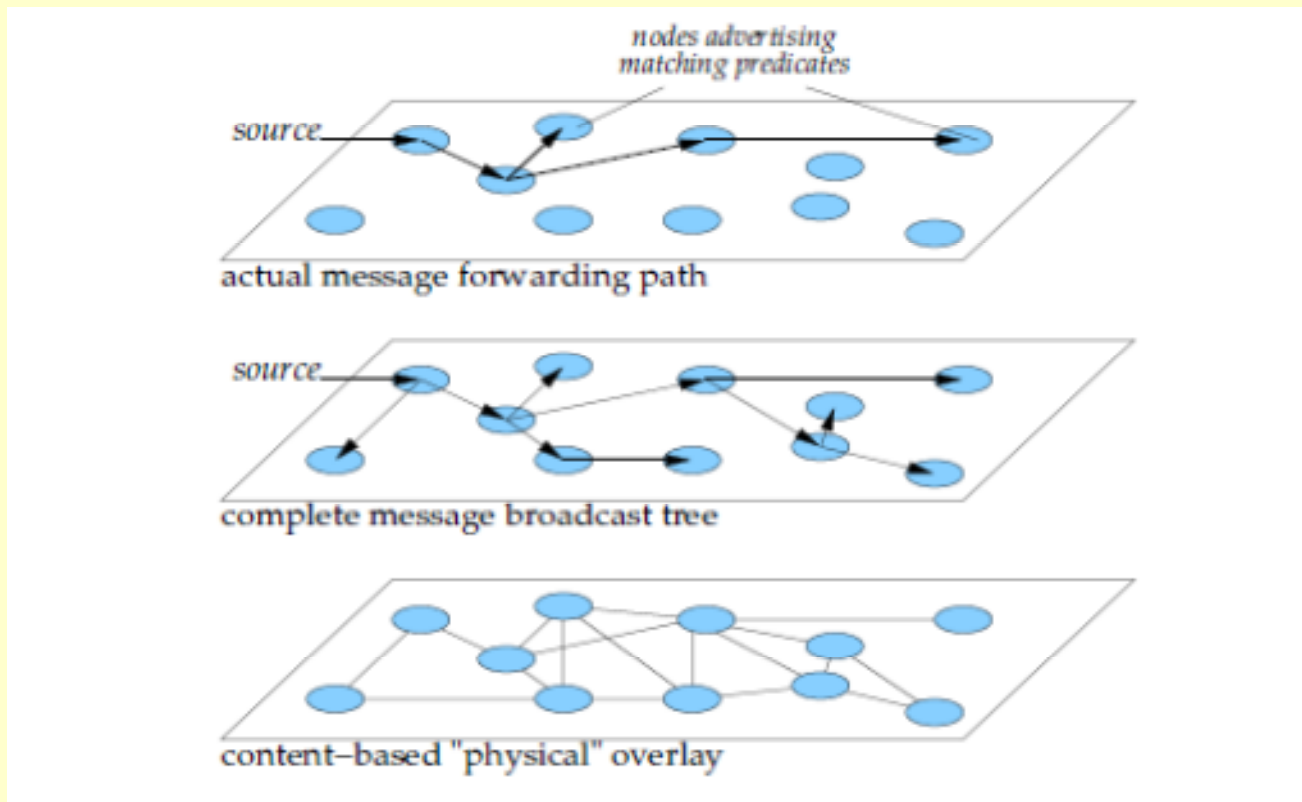

- Source: A.Carzaniga, M. J. Rutherford, A. L. Wolf, A Routing Scheme for Content-Based Networking,
 - http://www.inf.usi.ch/carzaniga/papers/crw_infocom04.pdf



3. Content Oriented Routing and Forwarding



- **Example 4: Content-Aware Network (cont'd)**
- A router runs two protocols :
 - a *broadcast routing* protocol
 - a *content-based routing* protocol.
-
- The broadcast protocol
 - creates a broadcast tree:
 - processes topological information
 - maintains the forwarding state necessary to send a message from each node to every other node.
 - There is a broadcast layer to execute broadcast tree construction
 - common broadcast schemes can be used maybe slightly modified
 - Implementation : global spanning tree protocol, per-source minimal-paths spanning trees, or reverse-path broadcasting.



3. Content Oriented Routing and Forwarding



- **Example 4: Content-Aware Network (cont'd)**
- **The content-based protocol**
 - processes *predicates advertised by nodes*,
 - maintains the forwarding state - to decide, for each router I/F whether a message matches the predicates advertised by any downstream node reachable through that interface.
- is based on a *dual push/pull* mechanism that guarantees robust and timely propagation of CB routing information

- **Message content:** structured as a set of *attribute/value pairs*, and a selection logical predicate (disjunction of conjunctions) of elementary constraints over the values of individual attributes
- Example: a message might have the following content
 - [class=alert, severity=6, device-type=web-server, alert-type=hardware failure]
- This content matches a selection predicate e.g. :
 - [alert-type=intrusion ^ severity>2 U class=alert ^ device-type=web-server]



CONTENTS



1. Introduction: Future Internet -Trends and Challenges
2. Content and Services Oriented Networking
3. Content Oriented Routing and Forwarding
4.  **Comparison of ICN/CON Approaches**
5. ALICANTE Project Solutions
6. Conclusions



4. Comparison of ICN/CON Approaches



- **Proposals analysed: CCN, PSIRP, DONA, Curling, 4WARD**
- **Common Characteristics**
- **Basic P/S Primitives.**
 - PUBLISH : information providers advertise the availability of their content
 - SUBSCRIBE: enables consumers to request content
 - Major P/S aspect: they decouple requests and responses in space and time: that
 - the provider and requester of the content need not know each other's location
 - they do not nor need be online at the same time.
- **ICN: ICN global-scale versions of P/S systems.**
 - Primitives similar to P/S:
 - CCN: REGISTER and INTEREST;
 - DONA : REGISTER and FIND;
 - Curling : REGISTER, PUBLISH and CONSUME



4. Comparison of ICN/CON Approaches



- **Proposals analysed: CCN, PSIRP, DONA, Curling, 4WARD**

- **Difference P/S- ICN**
 - ICN :the primitives act on the object name
 - (content published/subscribed to by name),
 - P/S : primitives have broader request semantics (e.g. describing content with various tags and allowing subscriptions to relate to any content described with that tag).
 - ICN: usually offer two options
 - one-time "fetch" operation (get content previously published under that name)
 - an ongoing "subscribe" operation (retrieving all future content published under that name)
 - P/S: most of systems support only option 2



4. Comparison of ICN/CON Approaches



- **Common Characteristics of ICN proposals [Ghodsi, 18, etc.]**
 - **Universal Caching (all contents, all users, all nodes)**
 - *All contents*: caching content carried by any protocol, (e.g., HTTP but not only).
 - *All users* : caching content of CPs but also content generated by users (total democracy)
 - *All nodes*: all ICN nodes makes caching (pervasiveness).
 - When a network element receives a request for content (from a peer or host),
 - (i) if it has the data cached, it can respond with the content directly, or
 - (ii) if it does not have the content cached, it can request the content from its peer(s)
 - **Security:**
 - ICN secure the content and not the the path,
 - content is signed by the original CP
 - network elements/consumers verify the content validity by verifying the signature



4. Comparison of ICN/CON Approaches



■ Differences Between Approaches

■ Interdomain Name-Based Routing

- Intra-domain routing is similar between proposals
- ***Inter-domain solutions: different***
 - name-based routing on top of BGP
 - DONA follows the BGP policy model but has its own name-based routing
 - others (e.g. PSIRP) have their own interdomain routing solution

■ Naming

- The consumer must know the content name wanted, CP's public key and should bind an object's name to the CP public key
 - hierarchical human-readable names
 - self-certifying names (key is bound to the name itself) – no need of PKI
 - but not human-readable



4. Comparison of ICN/CON Approaches



- **Differences Between Approaches (cont'd)**
- **Narrow Waist**
 - Narrow waist is often claimed as a major difference between ICN designs
 - However it seems to be [18 Ghodsi] a broader architectural debate, orthogonal to ICN
 - All of the ICN designs involve *hop-by-hop communication* between the ICN-layer elements
 - (CCN -Content Routers , PSIRP- Rendez-vous Nodes, DONA-Resolution Handlers, Curling-Content-aware Routers).
 - This hop-by-hop communication does not require global reachability → ICN can be run over IP, or over L2-like layer as a replacement for IP
 - Keeping or not IP as the narrow waist has implications for the overall Internet architecture, and ICN layer performance.



4. Comparison of ICN/CON Approaches



- **Open ICN research issues**
- **Content caching in every ICN node:**
 - **General ICN statement :** “content caching seen as an intrinsic and ubiquitous part of the network infrastructure would improve performance”
 - **Q: is it really completely true?**
 - A decade ago there was much research on *cooperative caching* [46, 47, 48],
 - each cache called upon another cache as needed before contacting the content server.
 - ICN works in similar style; ICN claimed that performance advantages come from widespread caching, which is essentially similar to cooperative caching
 - However it was shown that cooperative caching is unlikely to have significant benefits for larger organizations or populations (Wollman [45])
 - More recently, studies on Facebook’s caches use in their image-serving system show that the above conclusions still hold [49]



4. Comparison of ICN/CON Approaches



- **Open ICN research issues (cont'd)**
- **Content caching in every ICN node:**
 - **Content popularity issues:**
 - There exists a reasonable sized set of popular content, and a very long tail of content that is of interest to a small population.
 - Moderately sized **edge caches**, (as in today's CDN's use), are easily sufficient to handle the popular content.
 - For the long tail, the effectiveness of *caching increases logarithmically* with the size of the cache [50 Breslau]
 -
 - [Ghodsi, 18]:
 - “Is enough gain in changing the network architecture if the effectiveness of caching increases logarithmically, while the number of info objects increases exponentially”?
 - ICN brings benefits (better security model, intrinsic routing stability (i.e., loop-free), protection against DoS, ..
 - Q: Is it possible to get these advantages incrementally and not in clean slate way?
Given that some of the above advantages have been proposed already outside ICN concepts?



4. Comparison of CN/CON Approaches



- **Open ICN research issues (cont'd)**
- **Scaling issues**
 - The number of content objects is huge and rapidly growing.
 - Any ICN system should to handle at least 10^{12} objects
 - (result based on the current size of the web)
 - Requirement: routing decisions to be made at packet speeds → the routing table needs to be relatively small, $\sim 10^8$ entries or smaller
 - **How to achieve?**
 - - high levels of aggregation through hierarchical names.
 - But this is not easy feasible with multihoming of data
 - if no multihoming, ICN will have only one entry in its forwarding table (the originating content server- CS)
 - ICN nodes will route requests towards CS and will not be aware of any cached copies outside the default path to the server.
 - This caching-along default-path behavior does not worth to adopt a clean-slate ICN architecture (other solutions like HTTP proxy is more simple)



4. Comparison of CN/CON Approaches



- **Open ICN research issues (cont'd)**
- **Scaling issues**
- So there are alternatives
 - low speed of requests processing and allow multihoming
 - high speed of requests processing and accept simple caching along default route
- Other issue is *unbalance* between routing of requests (this can be done at lower speed) and data packets throughput which can be achieved at high speed of the packets
 - (after data location is known, the data transfer can be done at packet speed)
 - In other words the 1-to-1 relationship (Interest packet)-(Data packet) cannot be achieved if the request processing is slow, unless one accept lowering the data packets throughput



4. Comparison of CN/CON Approaches



- **Open ICN research issues (cont'd)**
- **Scaling issues**
 - **CISCO:**
 - How big is an ICN routing table?
 - what we need *today* ?
 - Assuming that future requirements growth will use up any future scalability improvements
 - Some ICN schemes such as DONA use a flat namespace
 - Self-certifying, better security, more flexible
 - Estimation: an Internet of flat labels would have to support $O(10^{**12})$ routes *today*
 - Google has indexed $>10^{**12}$ URLs
 - Web measured at $5 \times 10^{**10}$ ***text pages***
 - **This is six orders of magnitude beyond BGP**
 - not too much optimism to reach that anytime soon
 - need to compress the routing table..



4. Comparison of CN/CON Approaches



- **Open ICN research issues (cont'd)**
- **Narrow Waist: IP or ICN?**
- Equivalent question:
 - is the route-by-name the lowest-level global network primitive (i.e., the only way to establish global communication) or,
 - there is a lower-level address based network primitive that enables global reachability.

- [Ghodsi et.al., 18]:
- “Unless one adopts the cache-along-default-path design, we cannot do the name-based routing fast enough to make ICN the narrow waist”.
- “That is, one cannot have the network level primitive be something that cannot be processed at packet speeds”



4. Comparison of CN/CON Approaches



- **Open ICN research issues (cont'd)**

- **Narrow Waist: IP or ICN?**
 - Tradeoff between
 - naming (hierarchical or not)
 - routing behavior (just route to server, or route to nearest copy)
 - caching behavior (is the working set size small?)
 - the size of objects (they could be single packets only if the requests can be handled at packet speeds),
 - the narrow waist (**the waist must be able to operate at line speeds**)

 - [Ghodsi, 18]: Caching everywhere imply
 - To admit non-aggregated names , so large routing tables
 - But this means slow name-based routing
 - to avoid this we would need large ICN objects
 - so we we would need finally an IP waist ???

 - **Conclusion : one should further analyse if ICN can be really considered as Narrow waist**



4. Comparison of CN/CON Approaches



- **Open ICN research issues (cont'd)**
- **ICN/CON Privacy issues (summary)**

- **ICN/CON changes significantly the privacy model.**
- Current Internet: a client can establish a secure channel between itself and the CP ,
 - the requested content nature is known only to the client and the provider
- **ICN/CON**
 - Requested content name **is visible to all the ICN nodes processing the request.**
 - Reason:
 - ICN provides a get-by-name service
 - **One cannot hide the content name from the ICN infrastructure**
- Some recent work tries to improve CON privacy [Arianfar 53]:
 - *S. Arianfar, et. Al.,. On Preserving Privacy in Information-Centric Networks. In Proc of SIGCOMM, Workshop on ICN, 2011.*
 - **Non-trivial task!!**
- **To do:**
 - explore redesign of ICN systems for better support of privacy.
 - Solutions??:
 - special operations or services enabling content tunneling between publishers and subscribers
 - but the solutions should still allowing caching.



4. Comparison of CN/CON Approaches



- **Open ICN research issues (cont'd)**
- **Proposals [L.Popa, 54, Ghodsi, 18]:**
- Of interest: Can HTTP be turned into full-fledged ICN design?
 - **HTTP already supports some ICN/CON basic primitives**
 - Functions needed to turn HTTP into a full-fledged ICN design
 - caching for all content delivery: HTTP started to be widely used for most content delivery, so this objective is already investigated
 - caching at all network elements: possible solution- placing HTTP proxies on all routers?
 - CON security model: this is content naming and/or a PKI- related and not directly dependent on ICN design details.
 - Upgrading HTTP into a full-fledged ICN does not require additional research but is mainly a question of deploying known solutions
 - HTTP is already evaluated as candidate to be the next narrow waist of the Internet
 - *L. Popa, A. Ghodsi, and I. Stoica. HTTP as the Narrow Waist of the Future Internet. In Proc. of HotNets, 2010.*



CONTENTS



1. Introduction: Future Internet -Trends and Challenges
2. Content and Services Oriented Networking
3. Content Oriented Routing and Forwarding
4. Comparison of ICN/CON Approaches
5.  **ALICANTE Project Solutions**
6. Conclusions



5. ALICANTE Project Solutions



- **ALICANTE**, 2010-2013, Integrated Project (IP): Media Ecosystem Deployment Through Ubiquitous Content-Aware Network Environment- *FI oriented project*
- *<http://www.ict-alicante.eu/>*
- *19 European partners*
 - *Industry, SME*
 - *Operators*
 - *Universities*
 - *Research groups*



5. ALICANTE Project Solutions



- **Networked Media**
 - **Content Aware Networking (CAN) & Network Aware Application (NAA)**
 - **Evolutionary architecture** for networked media systems
 - Mid-way between traditional Internet solutions and full ICN
- **ALICANTE general objectives:**
 - **End users**
 - Flexible access to MM services, consume, share, generate A/V content
 - **Providers** (high level services, connectivity services)
 - extend their services range of for large number of users
 - efficiently manage their high level services and /or network resources
 - Flexible cooperation between providers, operators and end-users
 - Media services and network resources management in multi-domain, multi-provider environment
- **Novel virtual CAN) layer**
 - Content-Awareness delivered to Network Environment
 - Network- and User Context-Awareness to Service Environment
 - Different levels of QoS/QoE, security, etc. for media-oriented services
- **This presentation :**
 - **Content oriented routing and forwarding, caching concepts**

■ ALICANTE- High level architectural view

- **Environments:**
- *User (UE)* : End-Users terminals
- *Service (SE)*: Service and Content Providers
- *Network (NE)*, CAN Providers, Network Providers

“*Environment* “: groups of functions defined around the same functional goal and possibly spanning, vertically, one or more several architectural (sub-) layers.

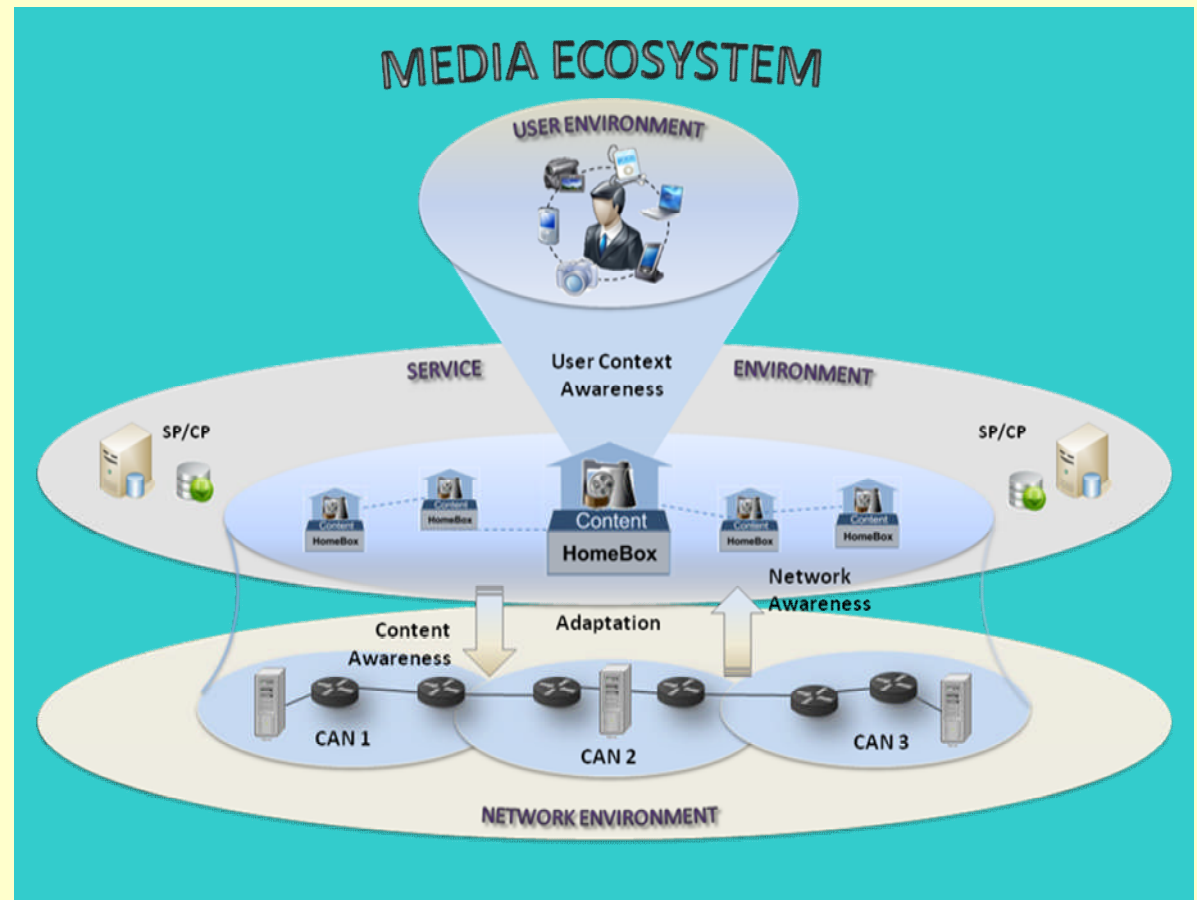



5. ALICANTE Project Solutions



Business Model

Business Actors:

- End-User (EU)
- Content Provider (CP)
- Service Provider (SP)
- Network Provider (NP)
- CAN Provider (CANP) (new)

Flexible Business Model : B2C, B2B, C2C and to consider new CAN features and service environment new capabilities

Cooperation, interaction:

- Single/aggregated roles of SP, CP, NP, ANP, C/SCs,
- Cooperation, via static and/or dynamic SLAs
- Distributed management
- Independent resource management of each actors' resources

Fully Managed Services (FM)

Partially managed Services (PM)

Unmanaged Services

- Include two point of views

Services: levels QoS requirements are

CANP: degree of the CAN layer freedom to perform autonomic actions

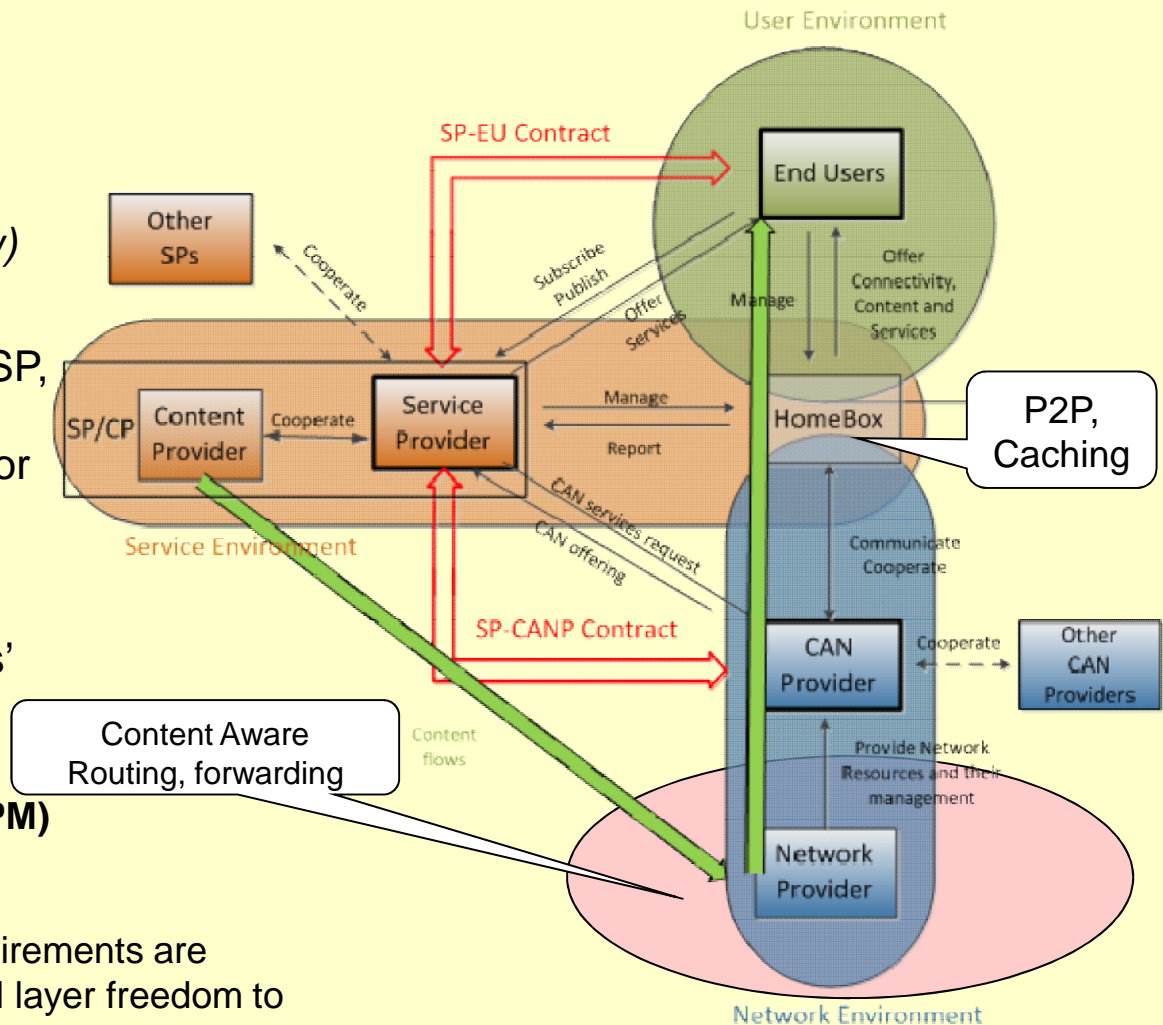



5. ALICANTE Project Solutions



- **ALICANTE architecture**
- Two virtual layers,
 - **CAN layer** for virtual connectivity services on top of the the core IP network
 - **Home-Box** layer- content delivery
- On top of the traditional IP Network layer, virtualising the network nodes in
- **User Environment**, seamlessly interacting with the underlying layers
- **Service Environment**, based on cooperation between the traditional SPs and End-Users (through their HBs)
- Combine **resource provisioning** at CAN layer with **adaptation** solution for the multimedia flow delivery over multi-domains
- Hierarchical **Multi-layered monitoring** sub-system at all defined levels: User, Service, Home-Box, CAN, Underlying network



5. ALICANTE Project Solutions



- **ALICANTE Architecture (cont'd)**
- *mid-way architecture* : CAN/NAA coupling, extendable both at service level and network/ transport level
- support integration
 - *vertical* (based on CAN/NAA) of high level services and connectivity ones,
 - *horizontal integration* on top of single or multiple-domain IP networks.
- network virtualization techniques is applied
 - to create parallel *content-aware virtual planes*
 - enriched in terms of functionality (due to content –awareness)
 - represented by *Virtual Content Aware Networks (VCANs)*
 - *Constrained routing and forwarding depending on content type*
 - VCANs spanning single or multiple IP domains

Overall Architecture View (1)

- User Env
- Service Env
- HB-layer
- Net Env
 - CAN layer
 - Infrastructure layer

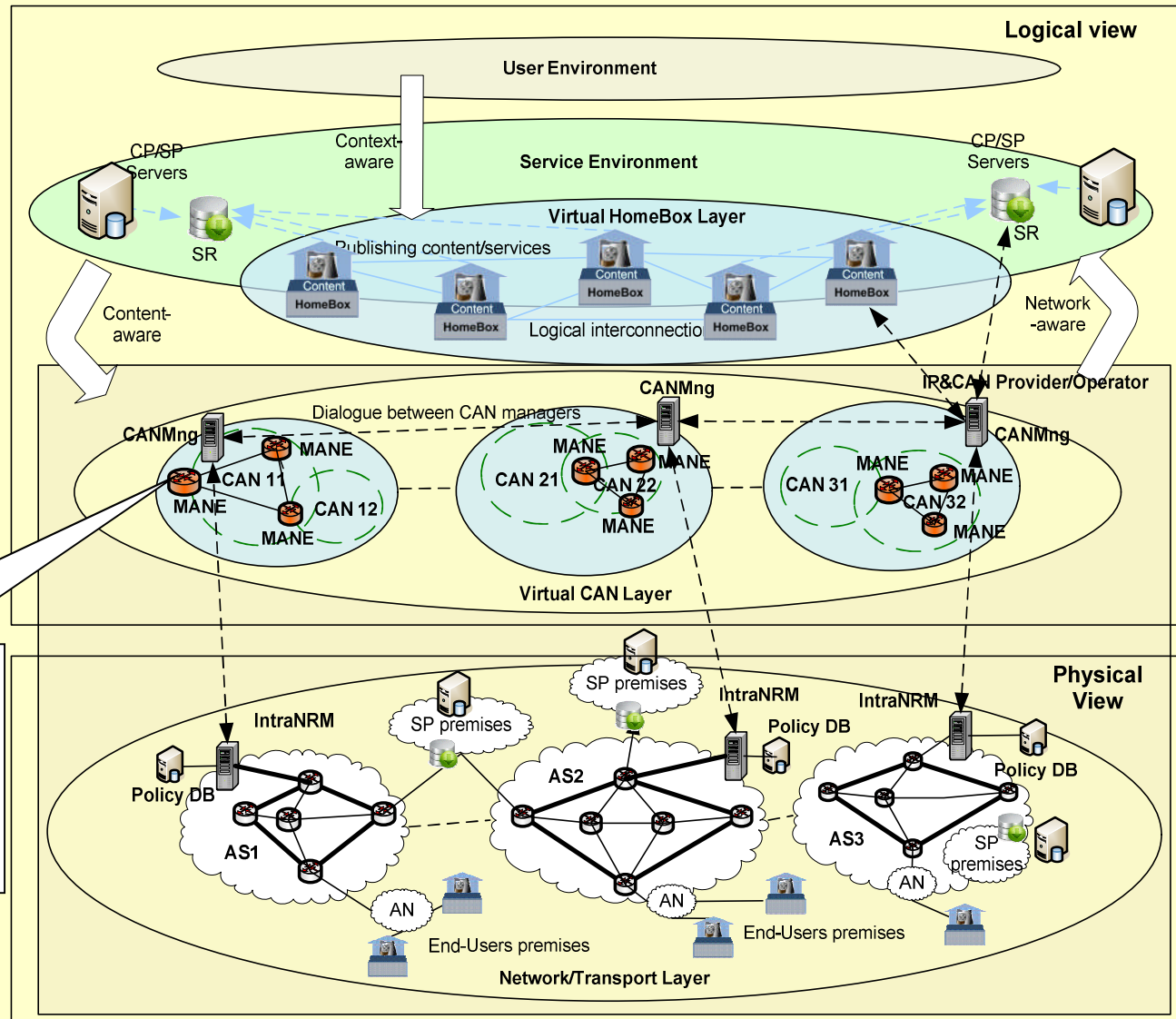

MANE – Novel ALICANTE router-Media Aware Network Element

- Unicast and Multicast Connectivity Services QoS enabled- adapted to content type
- Multicast Hybrid solution: IP multicast-intra-domain; Overlay Multicast –inter-domain;

Overall Architecture View (2)

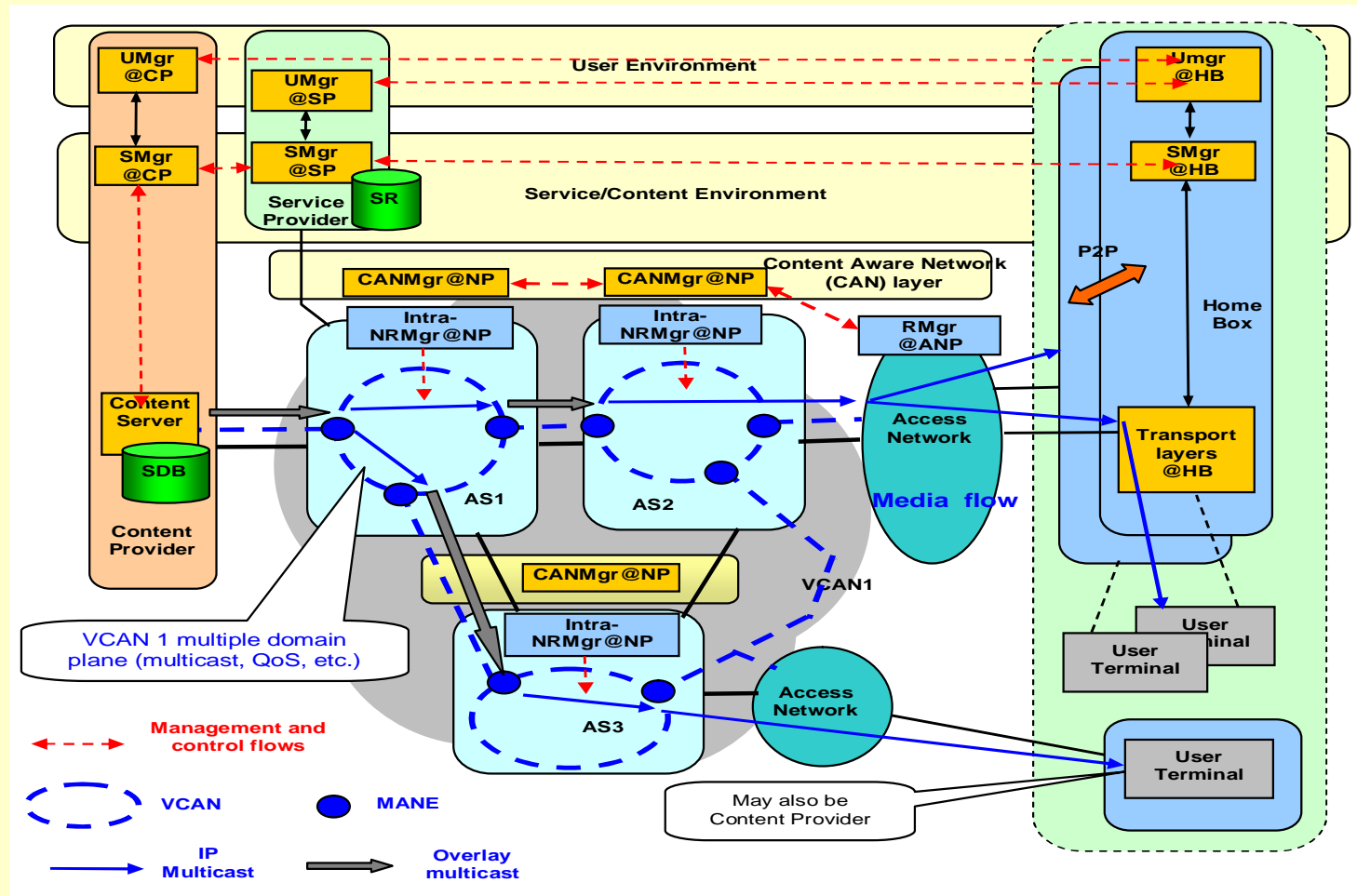



5. ALICANTE Project Solutions



- **Vertical and Horizontal Layering and functional splitting**
- **Virtual Content-Aware Network (V)CAN - layer**
 - Works on top of traditional IP network/transport layer
 - *Data Plane*
 - enhanced support for packet payload inspection, CA- processing and caching in network equipment
 - **improves QoS assurance via content-aware forwarding/routing**
 - increases network security level via content-based monitoring and filtering
 - 1:1, 1:n, n:m communications, P2P
 - *M&C Plane*
 - Distributed M&C: per domain CANMgr
 - Establish SLA/SLS between CANP and other business entities
 - Plan, provisioning, modifying VCANs in the form of parallel planes
- **The specific components of VCAN are the**
 - **Media-Aware Network Elements (MANE), i.e., the new CAN routers**
 - **CAN managers**



5. ALICANTE Project Solutions



- **Vertical and Horizontal Layering and functional splitting (cont'd)**
- ***Intra-domain Network Layer***
 - Traditional network TCP/IP layer
 - **Data Plane**
 - Implements VCANs by process data flows in CA style in MANE
 - Makes use of traditional network technologies to assure QoS, availability of paths
 - MPLS, Diffserv, etc.
 - IP multicast
 - **M&C Plane**
 - Managed by the Intra-domain Network Resource Manager (IntraNRM)
 - Having full authority on the network nodes and domain configuration
 - Cooperating with CANMgr in order to negotiate and install VCANs
 - IntraNRM
 - establish Network Interconnection Agreements with other IntraNRMs
 - Establish SLA with CAN Manager

ALICANTE Environments: contracts/interactions between BM actors

CANP – CAN Provider; SP/CP Service/Content Provider; CP – Content Provider; (A)NP – (Access) Network Provider; VCAN Virtual Content Aware Network; MANE Media Aware Network Element; HB – Home Box; AS – Autonomous System; AR – Access Router; EU – End User (terminal)

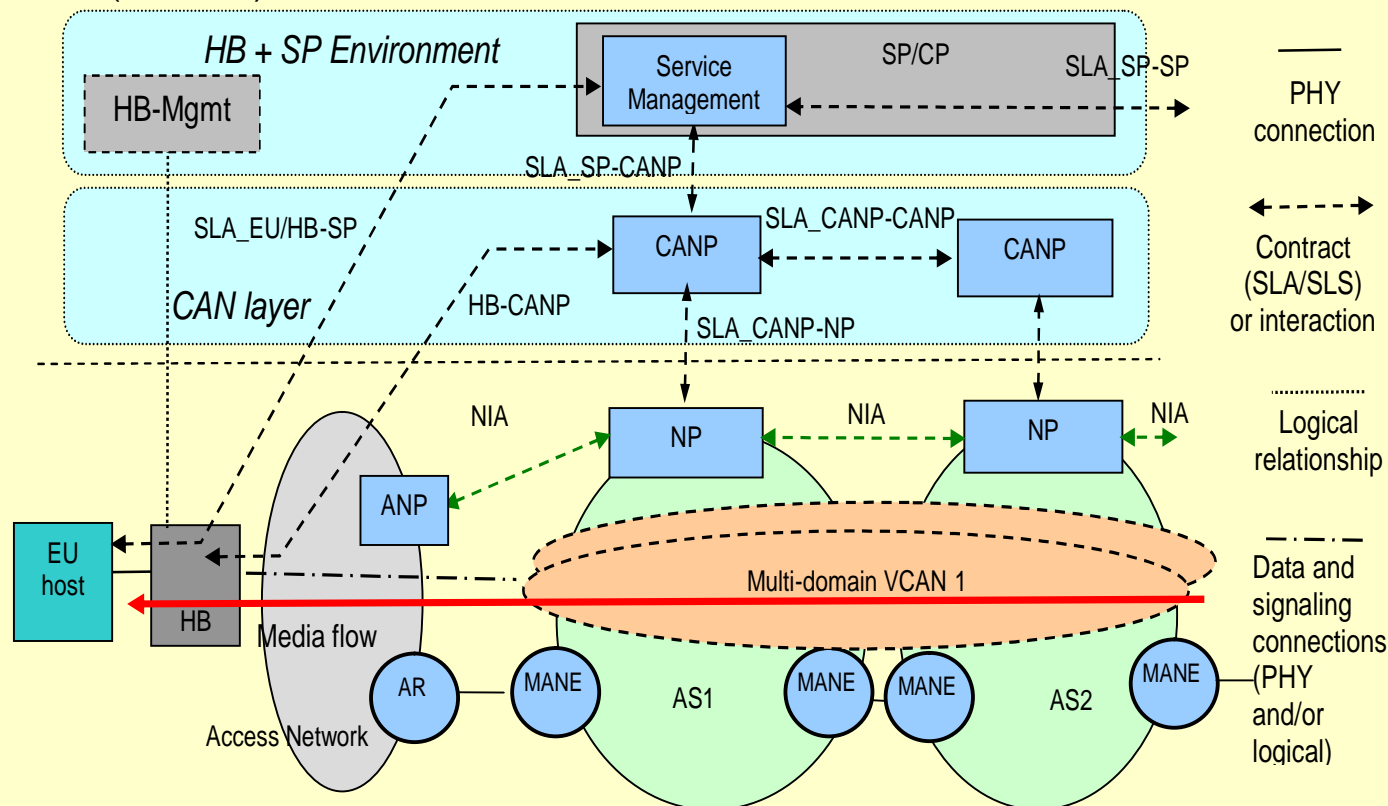

SLAs and Interactions for VCAN establishments

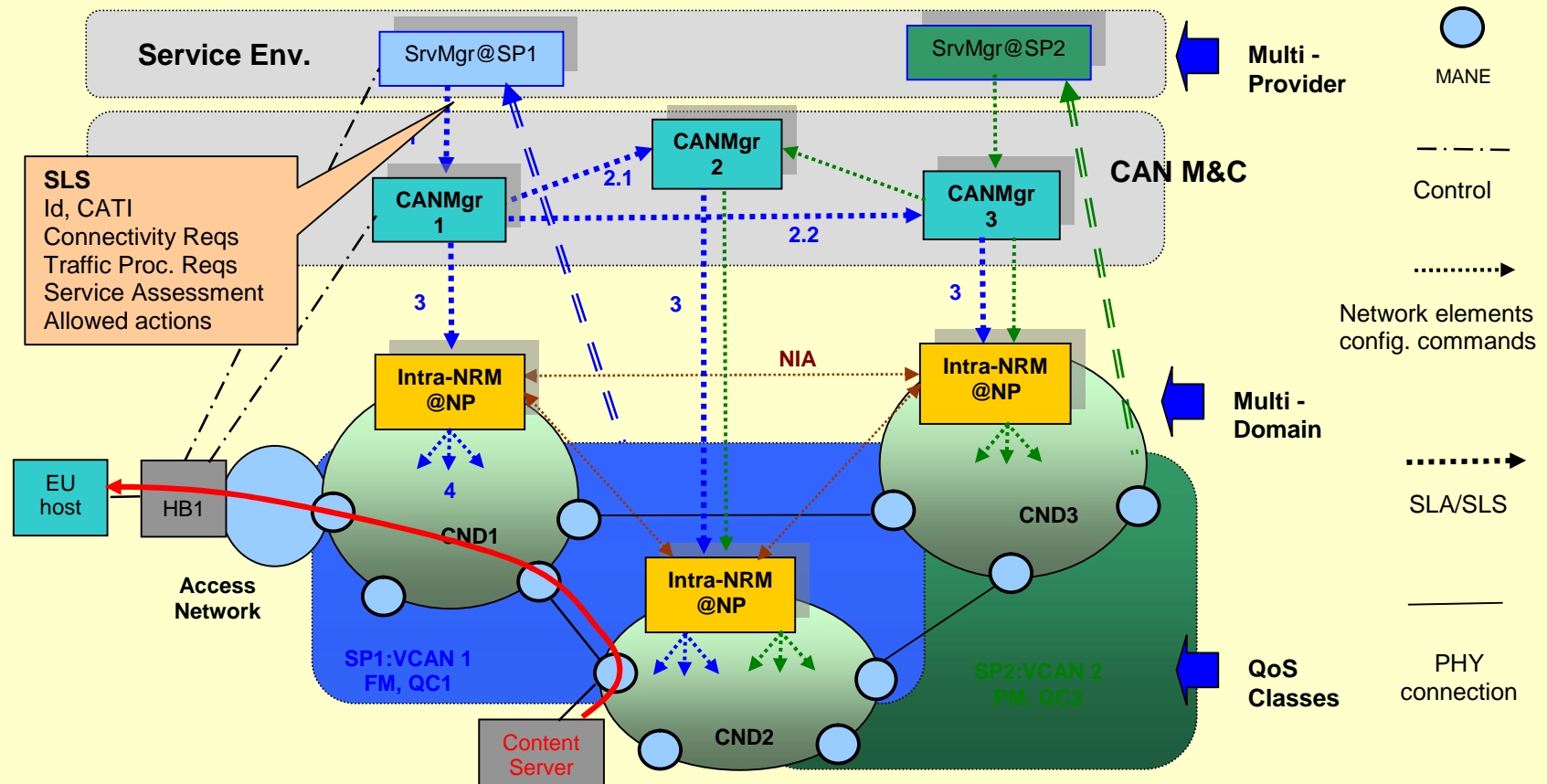



5. ALICANTE Project Solutions



- **Content Awareness and QoS at CAN Layer**
- CA is realized in three ways:
 - by concluding a SP - CANP SLA concerning different VCAN construction.
 - The content servers are instructed by the SP to insert some special Content Aware Transport Information (CATI) in the data packets.
 - SLA is concluded, but no CATI is inserted in the data packets (legacy CSs)
 - DPI packet inspection for data flow classification and assignment to VCANs
 - no SP-CANP SLA exists and no CATI.
 - The flows treatment can still be CA, local policy-driven at CANP and IntraNRM.
- The DiffServ and/or MPLS support splitting the sets of flows in QoS classes (QC) with a mapping between the VCANs and the QCs.
- Generally a 1-to-1 mapping between a VCAN and a network plane will exist.
- Several levels of QoS granularity for VCANs.
- The QoS behavior of each VCAN plane is established by the SP-CANP
- QoS classes (QC) :
 - meta-QoS classes ;
 - VCANs based on local QC composition
 - hierarchical VCANs based on local QC composition



5. ALICANTE Project Solutions



- **ALICANTE Content Awareness- Data Plane**
- Content Aware Transport Information
 - Can be inserted in data packets by the Content Servers
 - Analysed by MANE
 - Distributing the packet flows to appropriate VCANs
 - Forwarding inside this VCAN plane
- Still is possible to apply Content Awareness without CATI
 - Deep Packet Inspection of higher layer headers
 - Strtistical Analysis

	C A T I
B i t s	D e f i n i t i o n
1	U n i c a s t o r m u l t i c a s t m o d e
2	E x t e n s i o n h e a d e r p r e s e n c e
3	A d a p t a b i l i t y o f t h e s e r v i c e
4 - 7	S e r v i c e t y p e
8 - 1 0	S e r v i c e S u b - T y p e
1 1 - 1 2	S e r v i c e p r i o r i t y
1 3 - 1 8	V C A N l a b e l
1 9 - 2 6	E x t e n s i o n p u r p o s e s

VCAN Parallel Planes setup

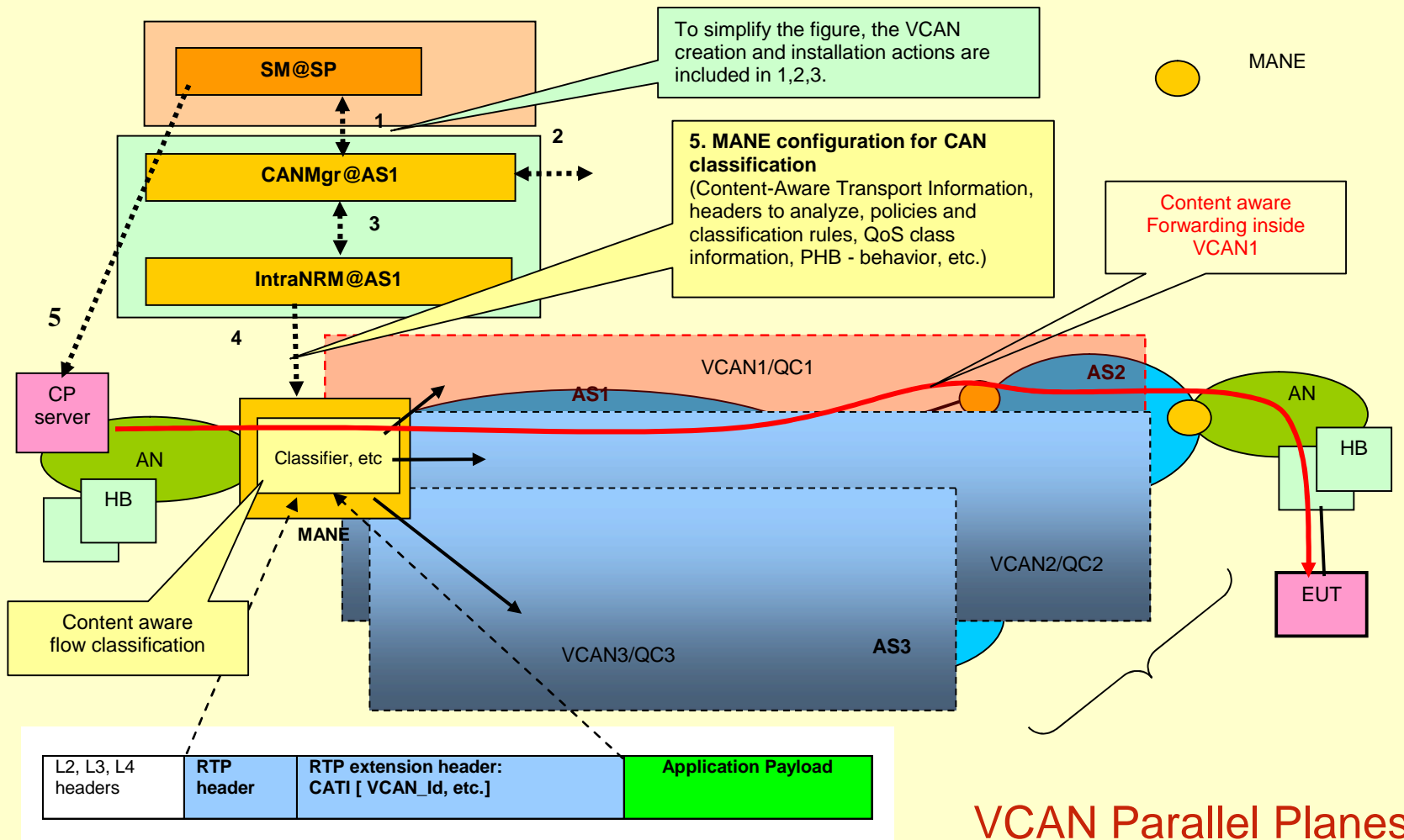

VCAN Parallel Planes



5. ALICANTE Project Solutions



- **CAN Multi-Domain Peering**
 - *Data plane topology* any kind -mesh/graph of domains
 - *Management and Control &C topology* - hub model
 - advantage that initiating CANMgr can know, each VCAN component (network) and its status
 - but each CANMgr should know the inter-domain topology (complete graph) of network domains.
 - Two functional components needed
 - (1) inter-domain topology discovery protocol;
 - (2) negotiation protocol for SLA/SLS between CAN Managers

- **Overlay Virtual Topology**
 - Each CND has complete autonomy w.r.t its network resources
 - The CANMgr cooperating with Intra-NRM is supposed to know about its network resources.
 - Abstract view at CANMgr level on network domain and output links towards neighbors in a form of a set of virtual pipes (called Traffic Trunks)
 - A set of such pipes can belong to a given QoS class.
 - A VCANs should also belong to some QoS class
 - inter-domain QoS aware routing info -> increase the chances of successful SLS establishment



5. ALICANTE Project Solutions



- **CAN Multi-Domain Peering (cont'd)**
 - **Virtual multi-domain topology.**
 - Each CDN can assure QoS enabled paths towards some destination network prefixes while implementing its own network technology: DiffServ, MPLS, etc.
 - Each CDN can be seen in an abstract way as an *Overlay Network Topology (ONT)* expressed in terms of *TTs (traffic trunks)* characterized by of bandwidth, latency, jitter, etc.
 - One TT is belonging to a given QoS class QCi
 - *Overlay Network Service (ONS)* responsible for getting the ONTs related to CDNs belonging to a multi-domain VCAN
 -
 - The CANMgrs will then inter-negotiate the SLS contracts in order to reserve VCAN resources and finally ask installation of them.
 - The overlay topology can be hierarchised on several levels.

CAN Multi-domain peering

CAN Layer: hub model (overlay inter-domain topology)

- Example of a multi-domain CAN (hub model)

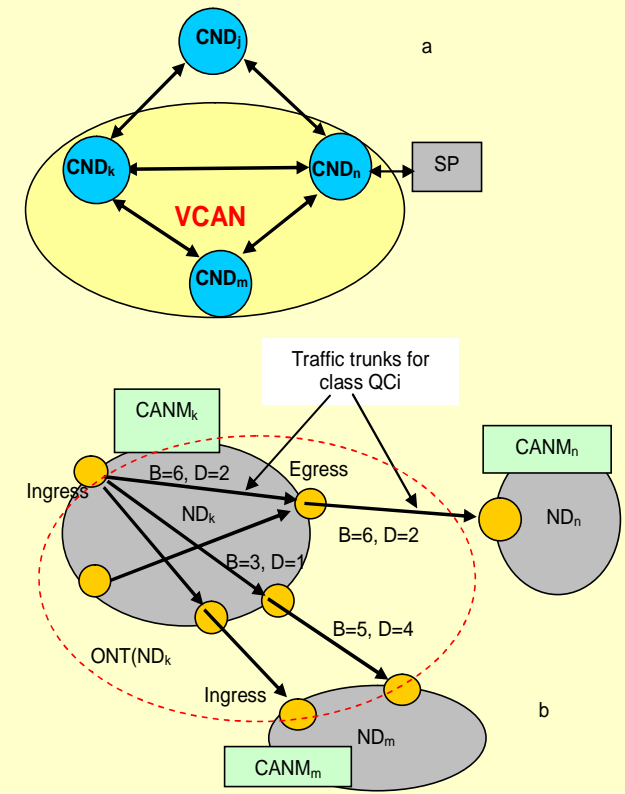
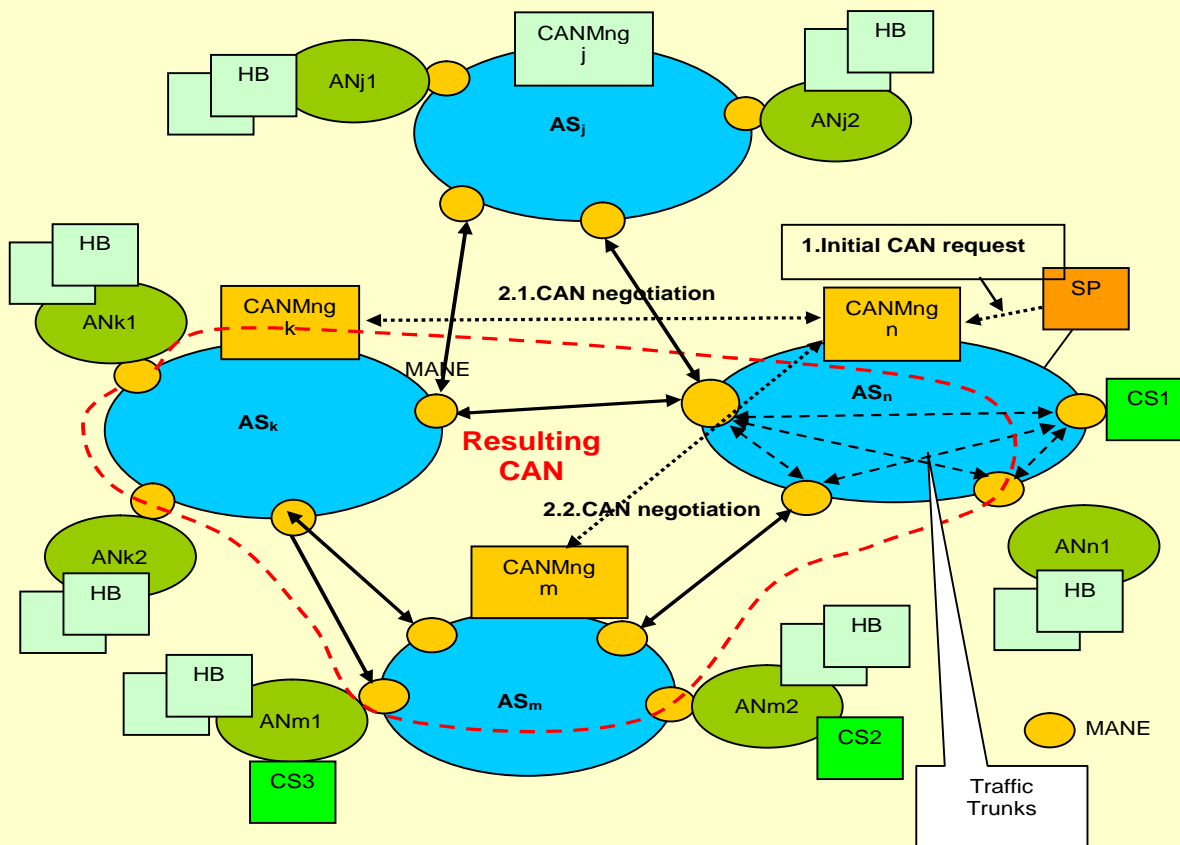

Abstracted view of the ONT



5. ALICANTE Project Solutions



- **CAN Negotiation and Provisioning**
 - CAN Provisioning Manager at SM@SP
 - performs the SP-CANP SLS processing - subscription (unicast/multicast mode) in order to assure the CAN transport infrastructure for the SP.
 - VCAN planning + negotiation with CAN Manager associated with its home domain, to subscribe for a new VCAN.
 - SLS concluded for unicast or multicast capable VCAN
 - Two phases of the VCAN construction
 - subscription: logical resource reservation at the CAN layer, not real resource allocation and network node configuration.
 - Actual resource allocation: at VCAN installation time
 - Initiator CAN Manager has to negotiate the CAN subscription
 - with other CANMgrs
 - with its Intra-NRM



5. ALICANTE Project Solutions



- **Inter-domain and Intra-domain CAN Planning and Resource Management**

- *Two level approach: Inter-domain and intra-domain*
- Combine the constrained **QoS routing** with **admission control (AC) resource reservation** and **VCAN mapping**, on two levels: inter-domain and then intra-domain.
- This split solves partially the scalability and also administrative problems of a multi-domain environment.
- The planning objectives are: using the ONT information and SP request to determine the domains participating to a given VCAN requested by SP
-
- Apply a QoS constrained routing algorithm AC and VCAN mapping
-
- Based on routing information the SLS splitting between domains is computed



5. ALICANTE Project Solutions



- **Inter-domain and Intra-domain CAN Planning and Resource Management**
- Example for inter-domain phase :
 - 1. SP issues a VCAN-0 request to initiator CANMgr1 (at CND1) i.e. an SLS request (topology, traffic matrix, QoS guarantees, ...etc.).
 - 2. The CANMgr1 obtains from ONTS the inter-domain level ONT (topology graph, inter-domain link capacities, etc.). The ONT is sufficiently rich to cover the required VCAN.
 - 3. The CANMgr1 determines the involved domains in VCAN-0 by using the border ingress-egress point's knowledge (actually MANE addresses) indicated in the SLS parameters
 - 4. The initiator CANMgr determines a contiguous inter-domain connectivity graph (including transit domains if necessary)
 - 5. CANMgr runs a combined inter-domain algorithm: *QoS routing with admission control (AC) resource reservation and VCAN mapping*
 - On inter-domain graph where each CND is abstracted as a node
 - Metric- for inter-domain links dependent on bandwidth and/or delay
 - Modified Dijkstra algorithm



5. ALICANTE Project Solutions



- **Inter-domain and Intra-domain CAN Planning and Resource Management**
- **Example for inter-domain phase (cont)**
- 6. The initiator CAN Manager splits the initial SLS among core network domains
 - This means to produce the set of SLS parameters valid to be requested to each individual CND
 - The *inputs* are: ONT graph, abstracting each CND by a node; QoS characteristics of the inter-domain links (bandwidth, delay); Traffic Matrix (and other QoS information) of the SLS proposed by SP
 - The *outputs* are the Traffic matrices for each CND composing the VCAN.
- 7. CANMgr negotiates with each CAN Mgr involved in hub style
- Each CANMgr applies a similar procedure for intra-domain

Inter-domain Path Selection and VCAN Mapping- Example

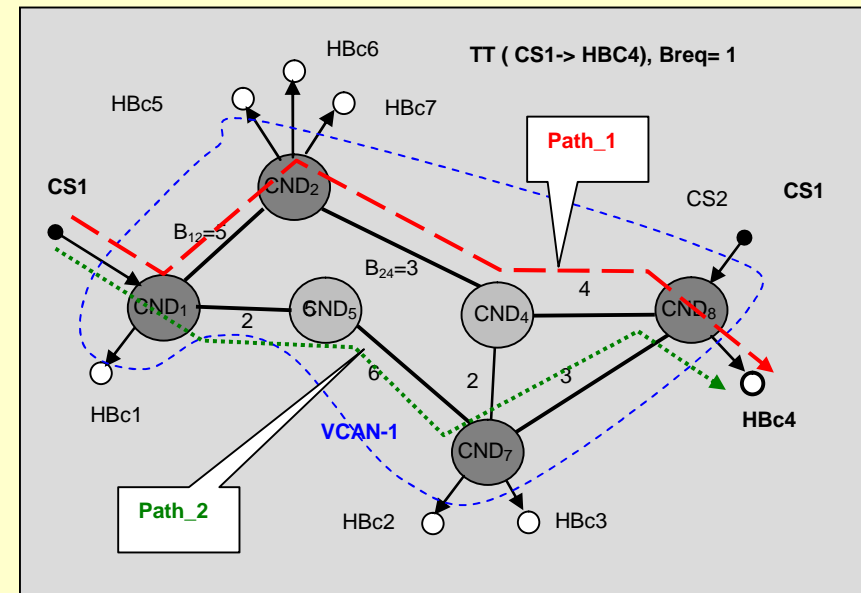
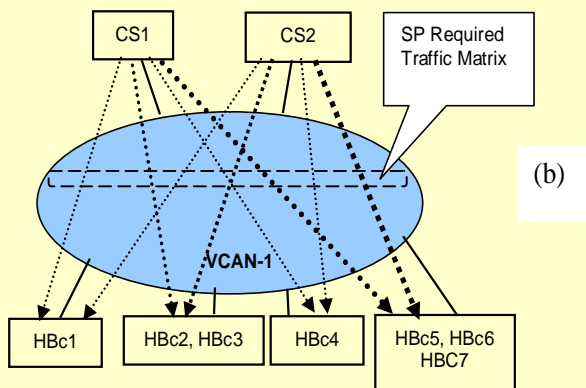
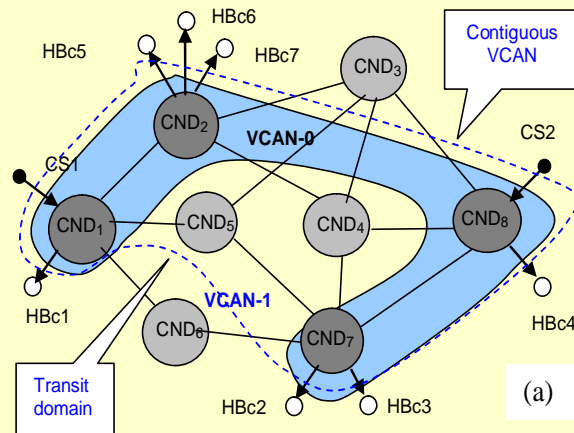

Example of cost of a inter-domain link (i,j) in the ONT

$$C(i,j) = Breq/Bij = Breq/Bavail,$$

B_{ij} = available bandwidth on this link and
Breq = bandwidth requested for that link

Or simplified one $C(i,j) = 1/Bij = 1/Bavail$
allow aggregated treatment of requests



5. ALICANTE Project Solutions



- **VCAN Mapping Optimisation and Scalability**
- Optimal mapping of overlay virtual networks onto real network substrate resources : NP-hard problem
- ALICANTE: pragmatic solution
 - VCAN construction actions have no strong real time constraints for computations
 - NP wants for given traffic matrix associated to a VCAN the least overall utilization
- Optimization possibilities:
 - compute the routing/mapping algorithm several times, for different order of requests and stop if a reasonable utilization degree is achieved
 - consider possible SP priorities when analyzing the requests
 - consider local NP policies

Intra-domain VCAN Mapping: variants for intra-domain mapping of VCANs and resource management (High Trust Medium Trust, Low Trust between CANMgr and Intra-NRM)

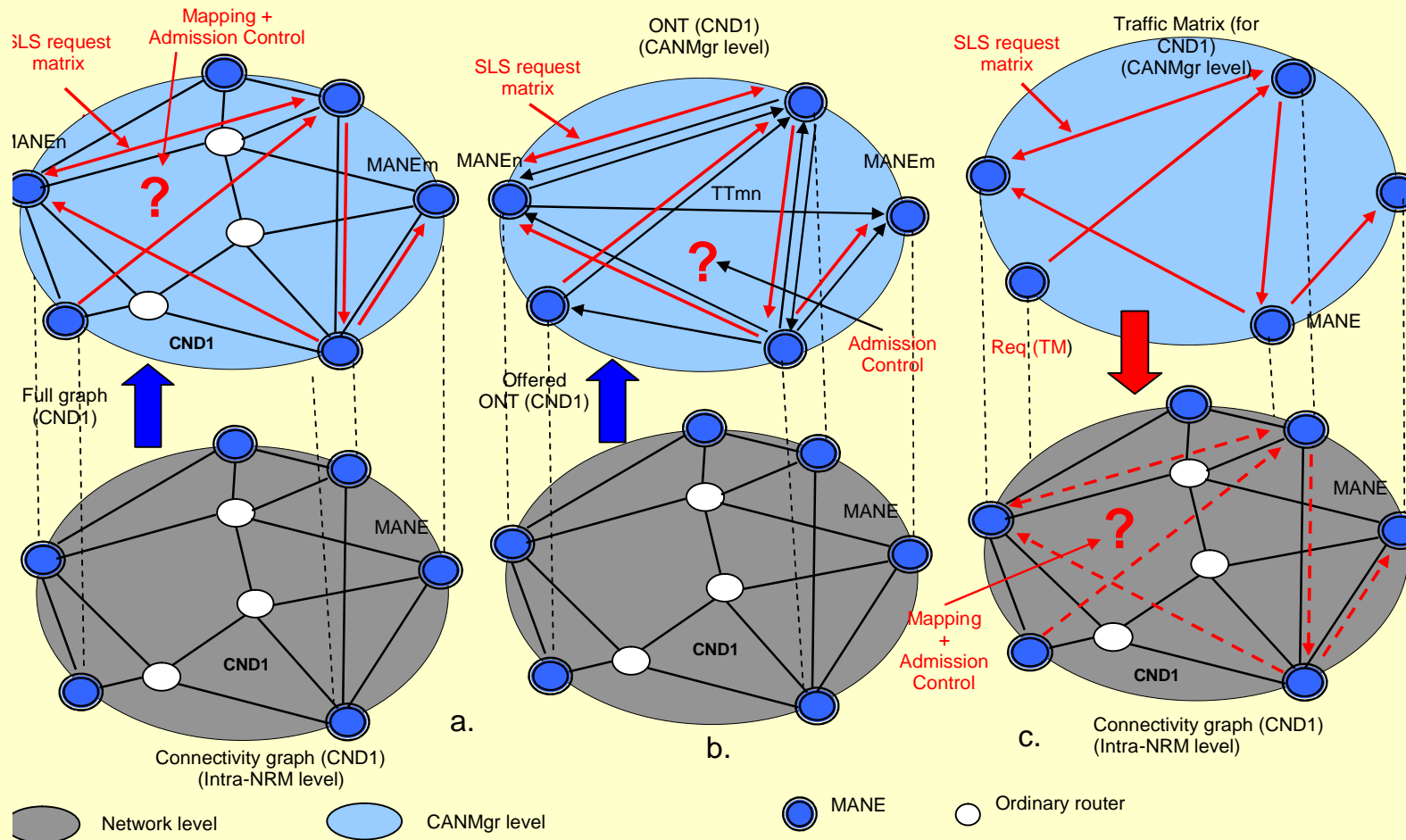



5. ALICANTE Project Solutions



- **CAN Layer:**
- **MANE/Content-Aware Network Router (CANR)**
 - Instructed on CA – via mgmt. and control plane
 - Recognizes data packets content type
 - content-type based processing (filtering, routing, forwarding adaptation, security operations, etc.)
 - and also depending on network properties and its current status.
- MANE basic set of functions :
 - *CA routing*
 - still preserve the std IP proactive protocols
 - But combining constrained QoS routing with VCAN mapping and resource reservation
 - *CA forwarding*: based on content-type extracted from packet fields' *Flow adaptation* : e.g considering SVC codes
 - *Specific Security processing*
 - Keep the traditional security procedures- plus specific treatment based on content type



5. ALICANTE Project Solutions



- **CAN Layer:**
- **MANE/Content-Aware Network Router (CANR)**
- Basic set of functions -details: (cont'd)
 - *Content-aware QoS and resource allocation:*
 - appropriate instances of VCAN will be assigned to flows depending on the level of QoS guarantees and network status
 - the MANEs deduce the QoS requirements of different flows based on the flows content
 - MANE will assign the flows to the appropriate CANs
 - The CAN layer will monitor the current load CANs
 - The MANE will maintain an aggregated image of flows that they forward
 - Efficient resource allocation and/or load balancing –possible



5. ALICANTE Project Solutions



- **ALICANTE content caching solutions**
- Caching policies + appropriate routing and forwarding-> increase the overall delivery efficiency

- ALICANTE caching:
 - HB overlay (edge caching points- different from full CON solution) caching
 - Content (e.g. video files) is placed in HB gradually if the content files are more requested (incremental solution)
 - the frequency of content objects in caches depends on their popularity
 - Algorithms for efficient caching distribution and replacing have been studied and are in implementation phase
 - K-means algorithms- have been used
 - Replacement policy: depends on the number of requests, popularity of the new objects requested, existing content objects popularity, distances between caching places and clouds of users, etc.



5. ALICANTE Project Solutions



- **ALICANTE content caching solutions (cont'd)**
- Simulation results
- ***Source: Ph.D Thesis Soraya Ait Chellouche, LABRI, Bordeaux, December 2011***
- **NS2 environment**
 - 5 ASs
 - 200 routers, 1GB/s connectivity
 - ~5 HB/Router, 100MB/s connectivity each HB
 - 1-4 clients /HB, different connectivity links $\in [0.512, 100]$ MB/s
 - One server/AS, connectivity of 2GB/s
 - 1 Service Registry, 1 Service Manager – 1GB/s
 - 10 000 video catalogue with three different resolutions
 - Popularity of video: zipf distribution $\alpha = 0.733$
 - Mean session duration: 5 min
 - Requests arrivals: Poisson 4-16 requests /client during 30 min
 - HB capacity : ≤ 5 videos, ≤ 5 parallel sessions



5. ALICANTE Project Solutions



- **ALICANTE content caching solutions**
- Simulation results: CDN versus CDN + HB support
 - Mean distance between clients and servers: (delay-based metric)

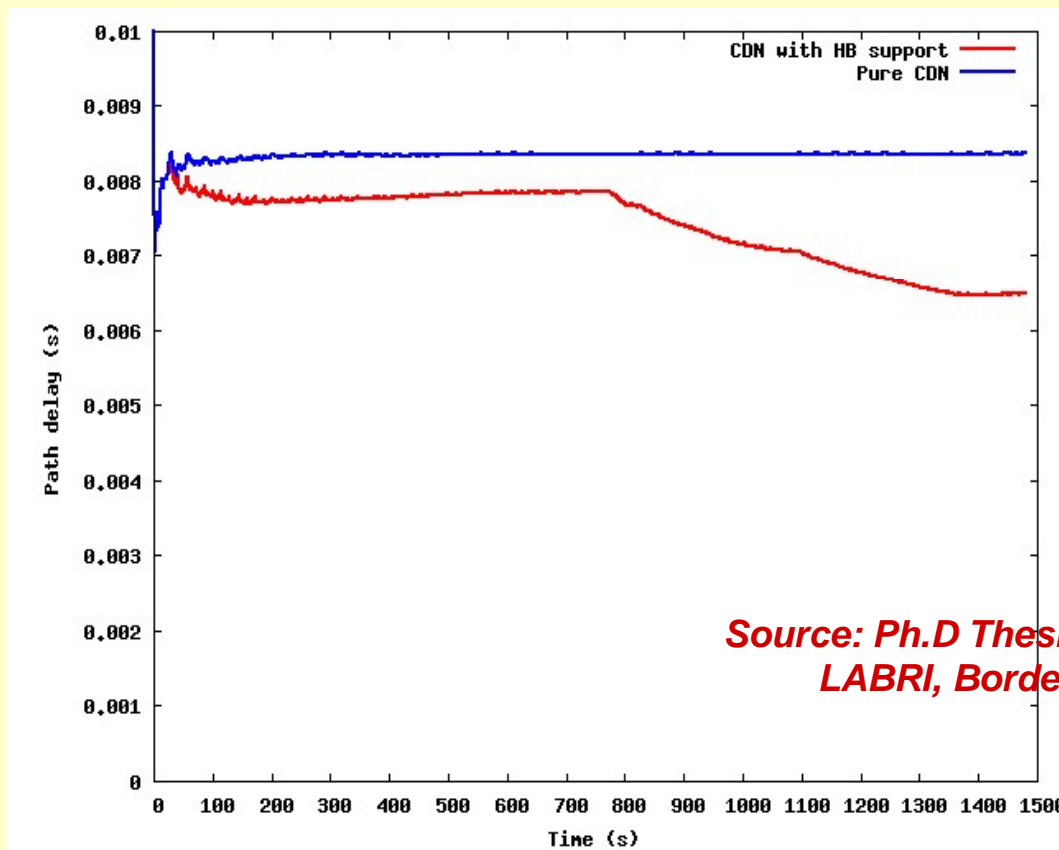

Source: Ph.D Thesis Soraya Ait Chellouche, LABRI, Bordeaux, December 2011



5. ALICANTE Project Solutions



- **ALICANTE content caching solutions (cont'd)**
- Simulation results

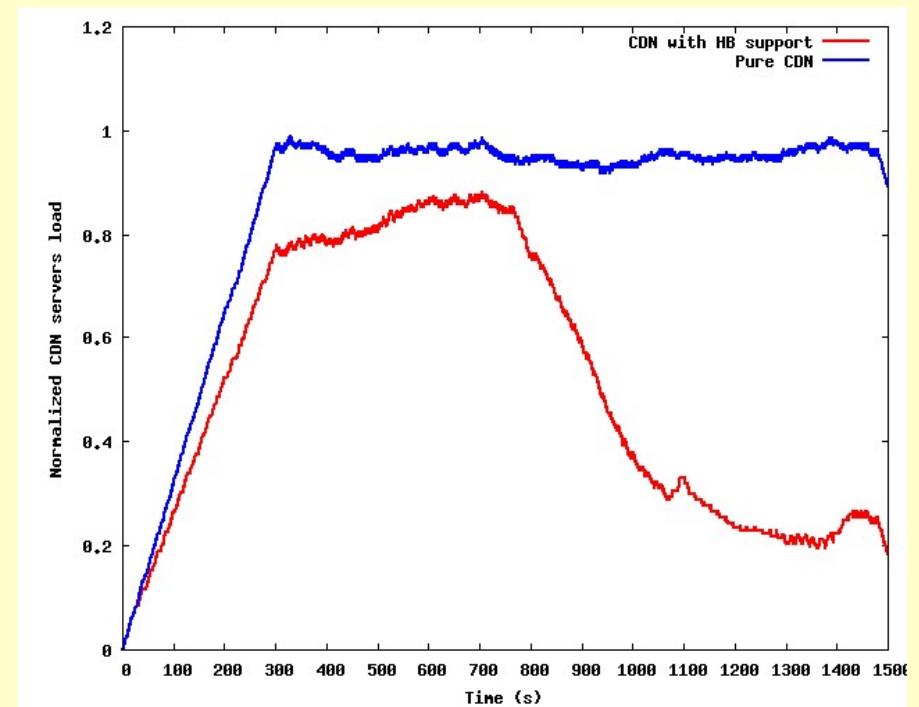
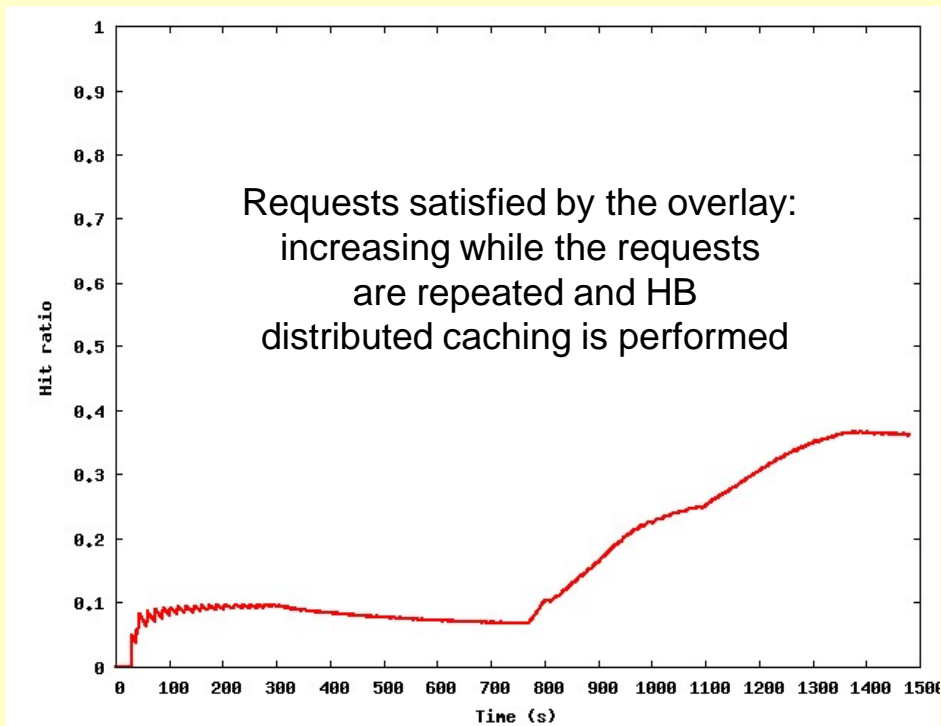

Server load during time – versus CDN traditional solution

Source: Ph.D Thesis Soraya Ait Chellouche, LABRI, Bordeaux, December 2011



5. ALICANTE Project Solutions



■ **Conclusions ALICANTE - Routing and Forwarding**

- **New architecture oriented to**
 - Content aware networking
 - Network aware applications
- **Mid-way solution :**
 - Still preserve the IP routing paradigm
 - However separates the Internet in parallel VCAN Planes – customised for different content type
 - Combines the networking provisioning technology with adaptation methods
- Allows multimedia oriented services to be developed in a flexible way
- More scalable than ICN/CCN
- Incremental deployment – possible
- Evolution towards ICN/CON - possible



CONTENTS



1. Future Internet : Trends and Challenges
2. Networked Media
3. Content and Services Oriented Networking
4. Content Aware Networking Architecture example:
ALICANTE project
5.  **Conclusions**



6. Conclusions



- **General open issues :**
 - How much to preserve the current network neutrality?
 - **Content Centric Networking/Content oriented networking –**
 - Revolutionary approach
 - new paradigm for IP networking
 - Content Aware Networking- Network Aware Applications
 - evolutionary approach: in the data plane mainly
 - traditional protocol stack modifications
 - Applications/services exist which
 - Are not primarily driven by content but by identity/location - VoIP, VC, etc. → combined solutions should be considered
 - Virtualisation – strong tool helping also CAN , CCN – still open to research
 - New business models are needed
 - Scalability, cost, backward compatibility?
 - Acceptance by the vendors, providers, operators of these new approaches ?



- Thank you !
- Questions?



References



1. J. Schönwälder, M. Fouquet, G., Dreo Rodosek, and Hochstatter, I.C., “Future Internet = Content + Services + Management”, IEEE Communications Magazine, vol. 47, no. 7, Jul. 2009, pp. 27-33.
2. C.Baladrón, “User-Centric Future Internet and Telecommunication Services”, in: G. Tselentis, et. al. (eds.), Towards the Future Internet, IOS Press, 2009, pp. 217-226.
3. J.Turner, and D.Taylor, “Diversifying the Internet,” Proc. GLOBECOM '05, vol. 2, St. Louis, USA, Nov./Dec. 2005, pp. 760-765
4. FUTURE INTERNET ASSEMBLY, Madrid, Spain, 9th – 10th December 2008, MEETING REPORT, December 2008
5. DG Information Society and Media Directorate, for Converged Networks and ServiceFuture Internet 2020, VISIONS OF AN INDUSTRY EXPERT GROUP, May 2009
6. G. Tselentis et al. (Eds.), Towards the Future Internet, IOS Press, 2009
7. Future Internet – Towards Research Challenges – 07 APR 2009, http://www.future-internet.eu/fileadmin/documents/prague_documents/FI_-_From_Functionalities2Challenges-09_04_08.pdf
8. Future Internet Initiatives, <http://www.nessi-europe.com/Nessi/> (Networked European Software and services initiative)
9. Report from the National ICT Research Directors Working Group on Future Internet (FI) of the EC on Information Society and Media- Nov. 2008
10. Pavlou G., Towards a Service-aware Future Internet Architecture, Future Internet Assembly – Madrid, Dec 2008
11. A. Galis et al., “Management and Service-aware Networking Architectures (MANA) for Future Internet Position Paper: System Functions, Capabilities and Requirements”, <http://www.future-internet.eu/home/future-internet-assembly/prague-may-2009>
12. Future Media Internet Architecture Reference Model, www.fi-nextmedia.eu /<http://initiative.future-internet.eu/news/view/article/future-media-internet-architecture-reference-model-white-paper.html>- 2011



References



13. A.Haider, Richard Potter and A. Nakao, “Challenges in Resource Allocation in Network Virtualization”, 20th ITC Specialist Seminar, 18.-20. May 2009, Hoi An, Vietnam, <http://www.itcspecialistseminar.com/paper/itcss09Haider.pdf>.
14. D.Kennedy, Networks + Content, Eurescom, Bled 2008
15. The FP7 4WARD Project , <http://www.4ward-project.eu/>
16. Abramowicz,H. Introduction to BIRD WS, <http://www.4ward-project.eu>
17. M. Gritter and D. R. Cheriton. TRIAD: A New Next-Generation Internet Architecture. <http://www-dsg.stanford.edu/triad/>, July 2000.
18. A.Ghods, T.Koponen, B.Raghavan, S.Shenker, A.Singla, J.Wilcox, Information-Centric Networking: Seeing the Forest for the Trees, <http://www.icsi.berkeley.edu/~barath/papers/icn-hotnets11.pdf>
19. D. Kutscher, B.Ahlgren, H.Karl, B. Ohlman, S.Oueslati I.Solis, Information-Centric Networking— Dagstuhl Seminar — 2011
20. Niranth, NGSON Architecture and Service Oriented Networking, http://www.gisfi.org/wg_documents/GISFI_SeON_201109146.pdf
21. J.Choi, Jinyoung Han, E.Cho, Ted Kwon, and Y.Choi,A Survey on Content-Oriented Networking for Efficient Content Delivery, IEEE Communications Magazine • March 2011
22. T. Koponen et al., “A Data-Oriented (and Beyond) Network Architecture,” SIGCOMM '07, 2007, pp. 181–92
23. G. Pavlou, Information-Centric Networking: Overview, Current State and Key Challenges, <http://www.ee.ucl.ac.uk/~gpavlou/>, IEEE ISCC 2011 Keynote
24. Van Jacobson, D.K. Smetters, J.D. Thornton, M. F. Plass, NH. Briggs, R.L. Braynard, Networking Named Content, Palo Alto Research Center, Palo Alto, CA, October 2009



References



25. W. K. Chai, N. Wang, I. Psaras G. Pavlou, C. Wang, G. García de Blas, F.J. Ramon Salguero, L. Liang, S. Spirou, A. Beben, E. Hadjioannou, "CURLING: Content-Ubiquitous Resolution and Delivery Infrastructure for Next-Generation Services" , IEEE Communications Magazine, March 2011, pp.112-120.
26. J. Choi, J. Han, E.Cho, T.Kwon, and Y.Choi "A Survey on Content-Oriented Networking for Efficient Content Delivery"IEEE Communications Magazine, March 2011pp. 121- 127
27. D. Adami et Al., "Design and Performance Evaluation of Service Overlay Networks Topologies", Journal of Networks , VOL. 6, NO. 4, April 201.
28. F. Verdi and M.F.Magalhaes, "Using Virtualization to Provide Interdomain QoS-enabled Routing", Journal of Networks, April 2007, pp. 23-32.
29. Zhi Li, P. Mohapatra, "QRON: QoS-Aware Routing in Overlay Networks", IEEE Journal on Selected Areas in Communications, VOL. 22, NO. 1, January 2004, pp.29-39.
30. Z. Wang, J. Crowcroft, "Quality-of-service routing for supporting multimedia applications", IEEE Journal on Selected Areas in Communications, vol. 14, no. 7, pp. 1228—1234, 1996.
31. J. Galán-Jiménez and A.Gazo-Cervero, "Overview and Challenges of Overlay Networks", International Journal of Computer Science & Engineering Survey (IJCSES) Vol.2, No.1, Feb 2011, DOI : 10.5121/ijcses.2011.2102 19
32. Z. Li, P. Mohapatra, and C. Chuah, Virtual Multi-Homing: On the Feasibility of Combining Overlay Routing with BGP Routing, University of California at Davis Technical Report: CSE-2005-2, 2005.
33. Luis M. Correia, An Academic View on Business and Regulatory Issues on the Future Internet, <http://www.4ward-project.eu/>
34. A. Mitra, M.Maheswaran, Wide-Area Content-based Routing Mechanism, International Parallel and Distributed Processing Symposium (IPDPS'03), <http://www.computer.org/portal/web/csdl/doi/10.1109/IPDPS.2003.1213447>
35. Barani Subbiah Zartash Afzal Uzmi Content Aware Networking in the Internet: Issues and Challenges, suraj.lums.edu.pk/~zartash/publications/2001-06-ICC-Content.pdf
36. A.Carzaniga, A. L. Wolf, Forwarding in a Content-Based Network, www.inf.usi.ch/carzaniga/papers/cw_sigcomm03.pdf



References



37. Editors: L.M. Correia and L.Lundgren, Going 4WARD Newsletter, 4WARD- Architecture and Design for the Future Internet May 2009, Issue No. 4
38. Subharthi Paul, Jianli Pan, and Raj Jain, Architectures for the Future Networks and the Next Generation Internet: A Survey
39. K. Visala et al., “An Inter-Domain Data-Oriented Routing Architecture,” ReArch '09: Proc. 2009 Wksp. Rearchitecting the internet, New York, NY, 2009, pp. 55–60
40. C.Tsilopoulos, G.Xylomenos, “Supporting Diverse Traffic Types in Information Centric Networks”, *ICN'11*, August 19, 2011, Toronto, Ontario, Canada.
41. E.Borcoci, D.Negru, C.Timmerer, “A Novel Architecture for Multimedia Distribution based on Content-Aware Networking” Proc. of CTRQ 2010, Athens, June 2010, pp. 162-168
42. <http://www.ict-alicante.eu/>
43. M. Boucadair, P. Lévi, D. Griffin, N. Wang, M. Howarth, G. Pavlou, E. Mykoniati, P. Georgatsos, B. Quoitin, J. Rodríguez Sánchez, M. L. García-Osma, “A Framework for End-to-End Service Differentiation: Network Planes and Parallel Internets”, *IEEE Communication Magazine*, Sept. 2007, pp. 134-143..
44. K.Cho, J. Choi, D.Ko, T.Kwon, Y.Choi, Content-Oriented Networking as a Future Internet Infrastructure: Concepts, Strengths, and Application Scenarios, http://mmlab.snu.ac.kr/~kdcho/publications/CON_CFI2008.pdf
45. A. Wolman, M. Voelker, N. Sharma, N. Cardwell, A. Karlin, and H. Levy. “On the Scale and Performance of Cooperative Web Proxy Caching” Proc. of SOSP, 1999.
46. L. Fan, P. Cao, J. Almeida, and A. Broder. Summary Cache: A Scalable Wide-area Web Cache Sharing Protocol. In Proc. Of SIGCOMM, 1998.
47. S. Michel, K. Nguyen, A. Rosenstein, L. Zhang, S. Floyd, and V. Jacobson. Adaptive Web Caching: Towards a New Global Caching Architecture. *Computer Networks and ISDN Systems*, 30(22-23), 1998.
48. M. Rabinovich, J. Chase, and S. Gadde. Not All Hits Are Created Equal: Cooperative Proxy Caching over a Wide-area Network.



References



49. D. Beaver, S. Kumar, H. Li, J. Sobel, and P. Vajgel. Finding a Needle in Haystack: Facebook's Photo Storage. In Proc. of OSDI, 2010.
50. L. Breslau, P. Cao, L. Fan, G. Phillips, and S. Shenker. Web Caching and Zipf-like Distributions: Evidence and Implications. In Proc. Of INFOCOM, 1999.
51. Content Mediator architecture for content-aware nETworks, (COMET). <http://www.comet-project.org/>.
52. Scalable and Adaptive Internet Solutions (SAIL), <http://www.sail-project.eu/>.
53. S. Arianfar, T. Koponen, B. Raghavan, and S. Shenker. On Preserving Privacy in Information-Centric Networks. In Proc of SIGCOMM, Workshop on ICN, 2011.
54. L. Popa, A. Ghodsi, and I. Stoica. HTTP as the Narrow Waist of the Future Internet. In Proc. of HotNets, 2010.
55. C. Intanagonwiwat, R. Govindan, D. Estrin, "Directed Diffusion: A Scalable and Robust Communication Paradigm for Sensor Networks", http://bnrg.eecs.berkeley.edu/~randy/Courses/CS268.F08/papers/24_diffusion.pdf
56. S. Eum, K. Nakauchi, T. Usui, Masayuki Murata, Nozomu Nishinaga "Potential Based Routing for ICN" <http://dl.acm.org/citation.cfm?id=2089035>