



WWW.IARIA.ORG

PANEL AICT/ICIMP

Quality and Risk Assessment in Telecommunications Services

Panel

- **Moderator**
 - > Moderator, Michael Massoth, Hochschule Darmstadt - University of Applied Sciences, Germany
- **Panelists**
 - > Branislav Jovic, Defence Technology Agency, New Zealand
Defence Force, New Zealand
 - > Flávio de Oliveira Silva, Federal University of Uberlandia, Brazil
 - > Claus-Peter Rückemann, Westfälische Wilhelms-Universität Münster (WWU) and Leibniz Universität Hannover and HLRN, Germany
 - > Simon Reay Atkinson, The University of Sydney, Australia



Assessment of Chaotic Communications

Branislav Jovic

22nd of July 2014

Chaotic signals in Communication Systems

➤ Are chaotic signals of mere academic interest or can they be implemented in practice for use within real time applications?

➤ Chaotic Communication Systems:

- Pecora-Carroll (PC) chaotic synchronization principles
- Spread Spectrum: CBDS-CDMA

➤ Issues:

- Implementation of chaotic signals in real time hardware: DSP processors and FPGAs
- Synchronization issues: Sufficiently robust techniques

Sensitivity to Initial Conditions and Parameters

- Chaotic systems generate chaotic signal that are highly sensitive to the system's initial conditions and parameters

$$x_{j+1}(1) = \left[\sum_{i=2}^N p(i) x_j(i) \right] \text{mod} 1,$$

$$x_{j+1}(i) = x_j(i+1) \quad (i = 2, 3 \dots N-1),$$

$$x_{j+1}(N) = x_j(1),$$

$$\xi(j) = x_j(1) + 0.5 \quad (j = 1, 2 \dots M),$$

Chaotic signal

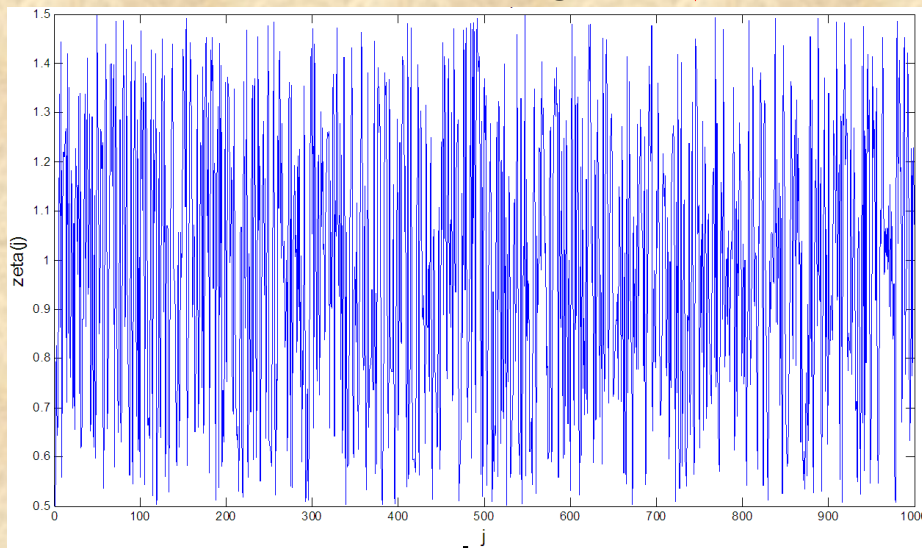

Chaotic signal

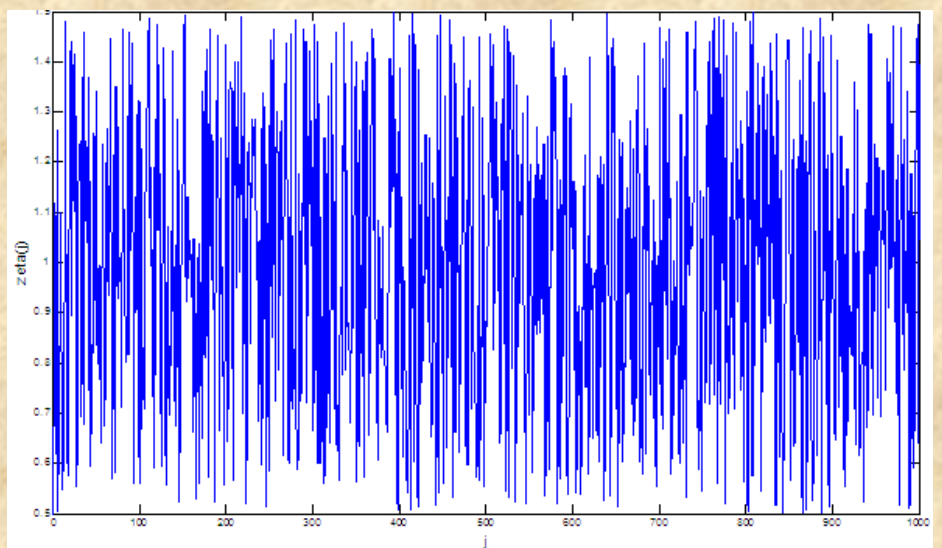

Synchronization Techniques

- Pecora-Carroll (PC) chaotic synchronization based chaotic communication systems offer an inherent system synchronization
- Spread Spectrum synchronization techniques implement the acquisition and tracking of the received chaotic signals to achieve robust synchronization of the CBDS-CDMA systems

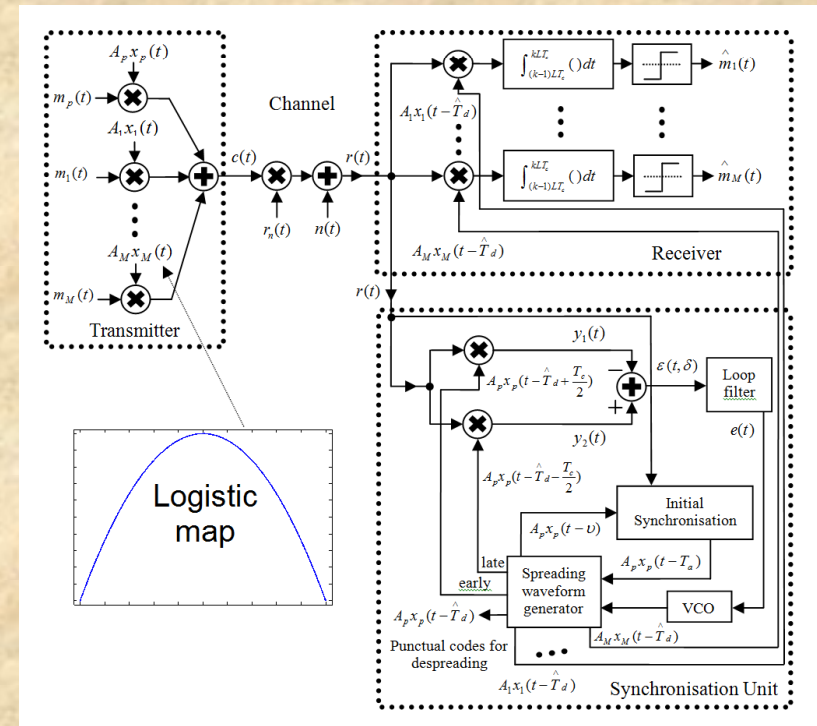
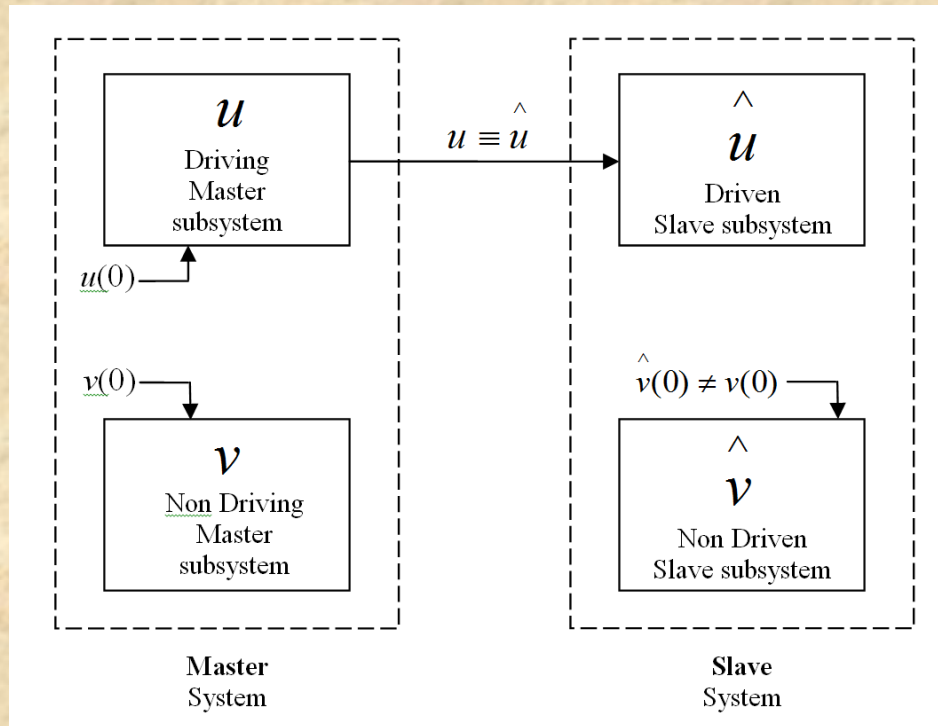

Chaotic signals in Communication Systems

- Potential to seek further robust synchronization techniques
- Development of real time chaotic communication systems
- Indirect application of chaotic signals to communications

AICT PANEL

Quality and Risk Assessment in Telecommunications Services

Prof. Flávio de Oliveira Silva, Ph.D.

Faculty of Computing

Federal University of Uberlândia

Minas Gerais, Brazil



Personal introduction

- Currently associate professor at Faculty of Computing from the Federal University of Uberlândia, Minas Gerais, Brazil
- Research interests are related with: Future Networks, Software Defined Networking, Autonomous and Intelligent Systems, Cloud Computing, Ubiquitous and Mobile Computing, Software based Innovation
- More than twenty years of experience in software development and consultancy at telecom operators and also internet service and content providers

About the Federal University of Uberlândia



- **Minas Gerais** is a state at the southeast region of Brazil
- Federal University of Uberlândia (UFU) is Higher Education Institution (HEI) funded by the Federal government of Brazil
- UFU has 1.600 professors and 32.000 students
- UFU offers 72 different undergraduate courses, 30 Masters of Science Courses, 20 Ph.D. Courses, distributed in different areas of knowledge

Assessment

- Risk assessment
 - Determination of quantitative or qualitative value of risk related to a concrete situation and a recognized threat
- Quality assessment
 - Quality control and continuous improvement
 - Executed by internal or external teams
- Quality Lifecycle

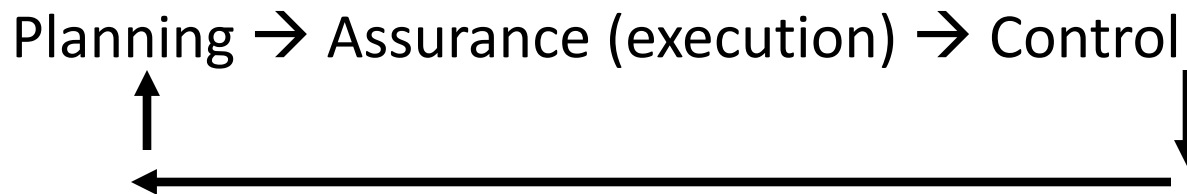

Quality and Risk

- Related with an sector, area, project or even a person at the organization
- Besides the budget are the top concerns in management
- Subject can be analyzed by different point of views
 - User
 - System
 - Network
 - Business
 - Government

Risk Types

- Compliance threats
 - originating in politics, law, regulation or corporate governance
- Operational threats
 - impacting the processes, systems, people and overall value chain of a business
- Strategic threats
 - related to customers, competitors and investors
- Financial threats
 - stemming from volatility in the markets and in the real economy

Top 10 risks in telecommunications [1]

1. Failure to realize new roles in evolving industry ecosystems
2. Lack of regulatory certainty on new market structures
3. Ignoring new imperatives in privacy and security
4. Failure to improve organizational agility
5. Lack of data integrity to drive growth and efficiency
6. Lack of performance measurement to drive execution
7. Failure to understand what customers value
8. Inability to extract value from network assets
9. Poorly defined inorganic growth agenda
10. Failure to adopt new routes to innovation

[1] Ernst & Young, "Top 10 risks in telecommunications 2014," 2014. [Online]. Available: <http://www.ey.com/GL/en/Industries/Telecommunications/EY-top-10-risks-in-telecommunications-2014>. [Accessed: 13-Jul-2014].

10. Failure to adopt new routes to innovation

- Sourcing innovation at an earlier stage
 - engaging and interacting with the world of technology startups in new ways
 - Italy - €4.5m investments in a range of start-ups including digital and green ICT (TIM)
 - Brazil – INOVA TELECOM (Innovation in Telecommunication) – R\$ 1.5b investment (Enterprises and ICTs) - non refundable to ICTs
 - Looking to attract the best in new talent
- Attracting and sustaining a wider range of talent
 - Ability to attract and sustain new types of talent
 - Align talent with the strategic vision
- ALGAR Telecom Experience

ALGAR Telecom

- Optical Fiber Backbone - 12.000 km

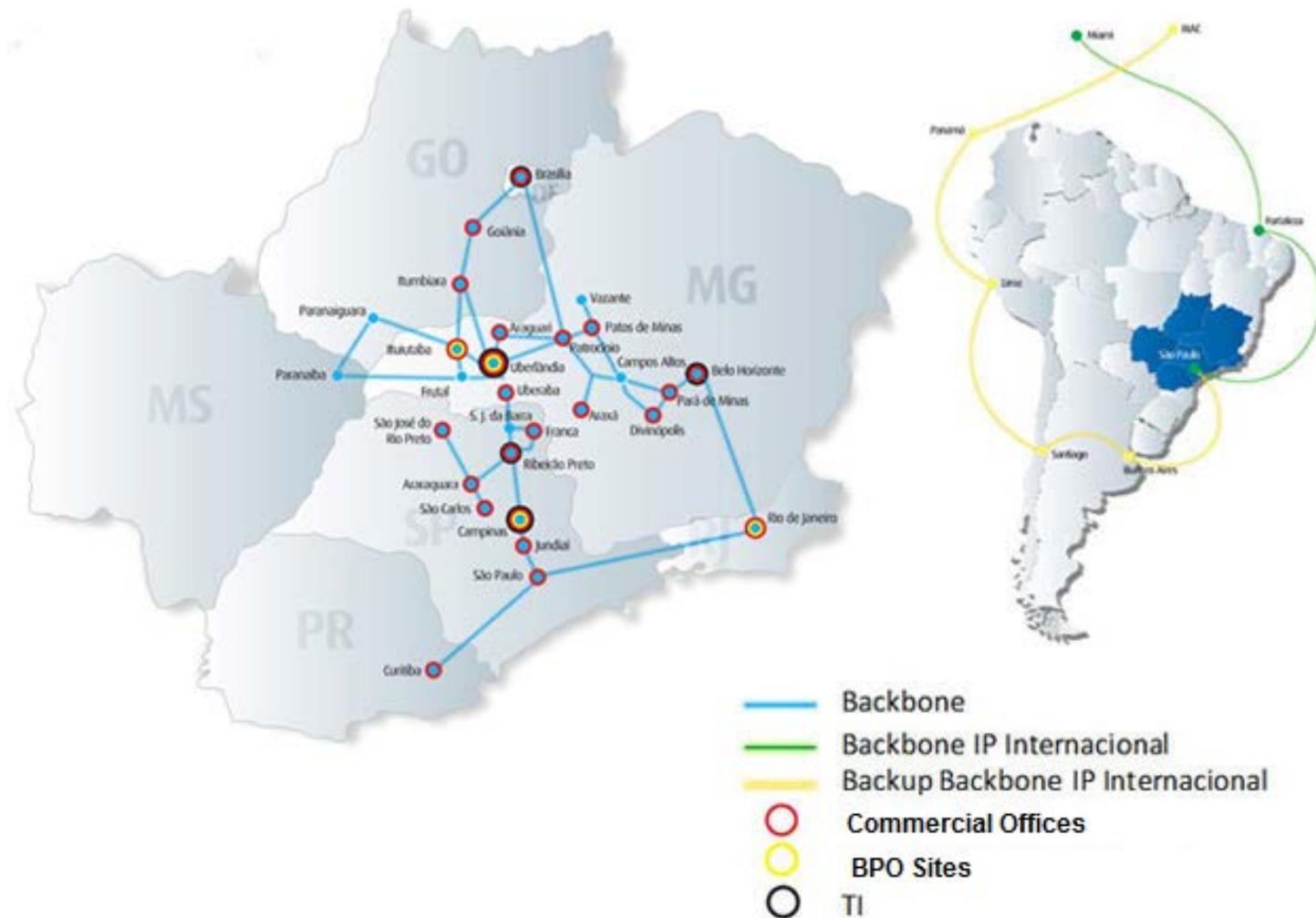

ALGAR Telecom

- New talent attraction program
 - Winners of contests based on the “ACM International Collegiate Programming Contest” model
- Strong investment in teams
 - Certification Program
 - Post-graduate courses
 - Research and Development
- In House development of solutions
 - Replacement from solutions from vendors
- INOVA Telecom
 - 12 projects

Questions? Discussion!



Thank you!
Suggestions? Collaborations? Contact us!

flavio@ufu.br

Prof. Flávio de Oliveira Silva
FACOM – Faculdade de Computação
UFU - Universidade Federal de Uberlândia

AICT PANEL

Quality and Risk Assessment in Telecommunications Services

Prof. Flávio de Oliveira Silva, Ph.D.

Faculty of Computing

Federal University of Uberlândia

Minas Gerais, Brazil



Personal introduction

- Currently associate professor at Faculty of Computing from the Federal University of Uberlândia, Minas Gerais, Brazil
- Research interests are related with: Future Networks, Software Defined Networking, Autonomous and Intelligent Systems, Cloud Computing, Ubiquitous and Mobile Computing, Software based Innovation
- More than twenty years of experience in software development and consultancy at telecom operators and also internet service and content providers

About the Federal University of Uberlândia



- **Minas Gerais** is a state at the southeast region of Brazil
- Federal University of Uberlândia (UFU) is Higher Education Institution (HEI) funded by the Federal government of Brazil
- UFU has 1.600 professors and 32.000 students
- UFU offers 72 different undergraduate courses, 30 Masters of Science Courses, 20 Ph.D. Courses, distributed in different areas of knowledge

Assessment

- Risk assessment
 - Determination of quantitative or qualitative value of risk related to a concrete situation and a recognized threat
- Quality assessment
 - Quality control and continuous improvement
 - Executed by internal or external teams
- Quality Lifecycle

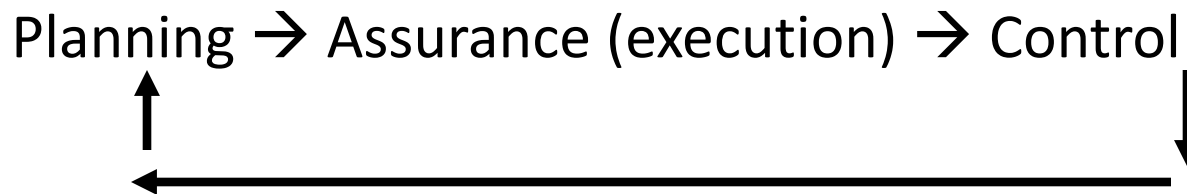

Quality and Risk

- Related with an sector, area, project or even a person at the organization
- Besides the budget are the top concerns in management
- Subject can be analyzed by different point of views
 - User
 - System
 - Network
 - Business
 - Government

Risk Types

- Compliance threats
 - originating in politics, law, regulation or corporate governance
- Operational threats
 - impacting the processes, systems, people and overall value chain of a business
- Strategic threats
 - related to customers, competitors and investors
- Financial threats
 - stemming from volatility in the markets and in the real economy

Top 10 risks in telecommunications [1]

1. Failure to realize new roles in evolving industry ecosystems
2. Lack of regulatory certainty on new market structures
3. Ignoring new imperatives in privacy and security
4. Failure to improve organizational agility
5. Lack of data integrity to drive growth and efficiency
6. Lack of performance measurement to drive execution
7. Failure to understand what customers value
8. Inability to extract value from network assets
9. Poorly defined inorganic growth agenda
10. Failure to adopt new routes to innovation

[1] Ernst & Young, "Top 10 risks in telecommunications 2014," 2014. [Online]. Available: <http://www.ey.com/GL/en/Industries/Telecommunications/EY-top-10-risks-in-telecommunications-2014>. [Accessed: 13-Jul-2014].

Risks x Types

1. Failure to realize new roles in evolving industry ecosystems
2. Lack of regulatory certainty on new market structures
3. Ignoring new imperatives in privacy and security
4. Failure to improve organizational agility
5. Lack of data integrity to drive growth and efficiency
6. Lack of performance measurement to drive execution
7. Failure to understand what customers value
8. Inability to extract value from network assets
9. Poorly defined inorganic growth agenda
10. Failure to adopt new routes to innovation

Figure 1. Top 10 risks in telecommunications 2014

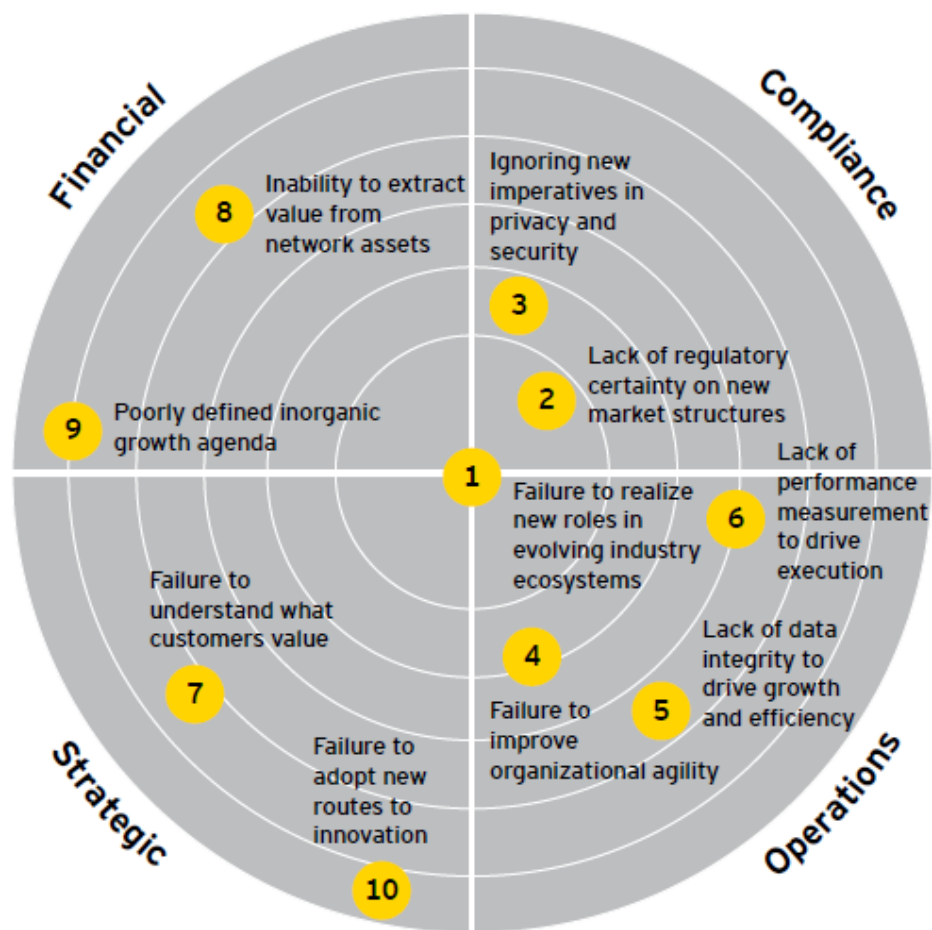

1. Failure to realize new roles in evolving industry ecosystems

- New growth opportunities require new value chain positioning

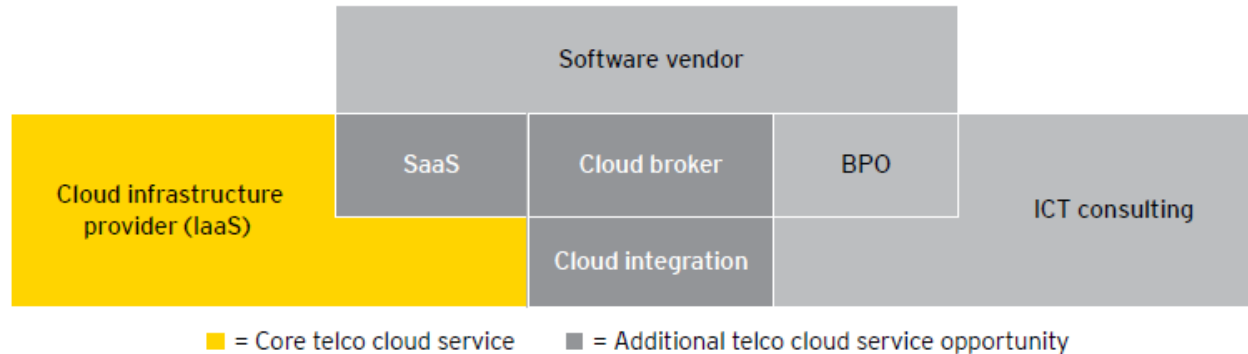

Source: EY analysis.

- Sharing customer ownership with disruptive players
 - bundling music streaming as part of mobile data packages
 - operators choose to partner with application providers, a number of tactical and strategic options emerge
 - convergence of mobile payments and location-sensitive marketing capabilities
 - operators must take a holistic view of new digital ecosystems

2. Lack of regulatory certainty on new market structures

- Attitudes to consolidation and cross-sector relationships are in flux
 - Market conditions for operators remain highly challenging (including price deflation driven by competition, new market players)
 - Regulatory environment is the leading reason for telecoms not to pursue acquisitions
 - Net neutrality issues in several countries
- Operators must help shape new regulatory attitudes
 - To drive progress, operators need to seize the initiative (in-market consolidation versus network sharing)

3. Ignoring new imperatives in privacy and security

- Consumer trust levels are in decline as regulators revisit data protection guidelines
 - negative headlines about telecoms and data privacy
 - This happens with other ecosystem players such as app developers and social networks
 - Data privacy x data sovereignty x Internet governance
 - Countries from Germany to Brazil are considering new ways of ensuring the integrity of national data
- New opportunities are opening up for differentiation
 - Trust levels that can in turn help to unlock new service scenarios (improved privacy and security are vital to the take-up of services such as mobile payments)
 - secure cloud and connectivity services
 - Proactive stances are required on privacy and security issue

4. Failure to improve organizational agility

- Greater agility is essential in a more diverse industry ecosystem
 - require operators to overhaul their silo based organizational structures for more flexibility and agility
 - need to develop and launch new service propositions more quickly as technology cycles shorten

4. Failure to improve organizational agility

- Fostering flexibility and innovation from within
 - “Launch and learn” mindset
 - Evolution of systems and processes

Figure 13. Opportunities for transformation of people and processes

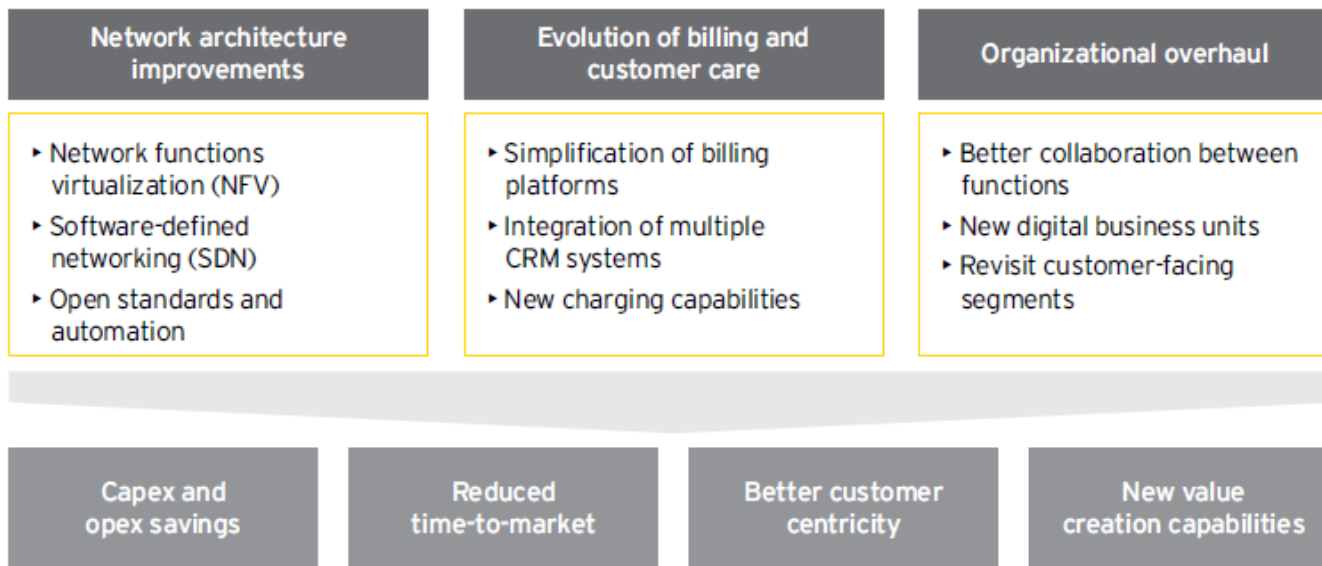

Source: EY analysis.

5. Lack of data integrity to drive growth and efficiency

- Data integrity requires organizational overhaul
 - lack of cooperation within the organization, fragmentation of data sources all impeding progress
- Moving from big data to better data

Figure 15. Sample big-data use cases for telcos

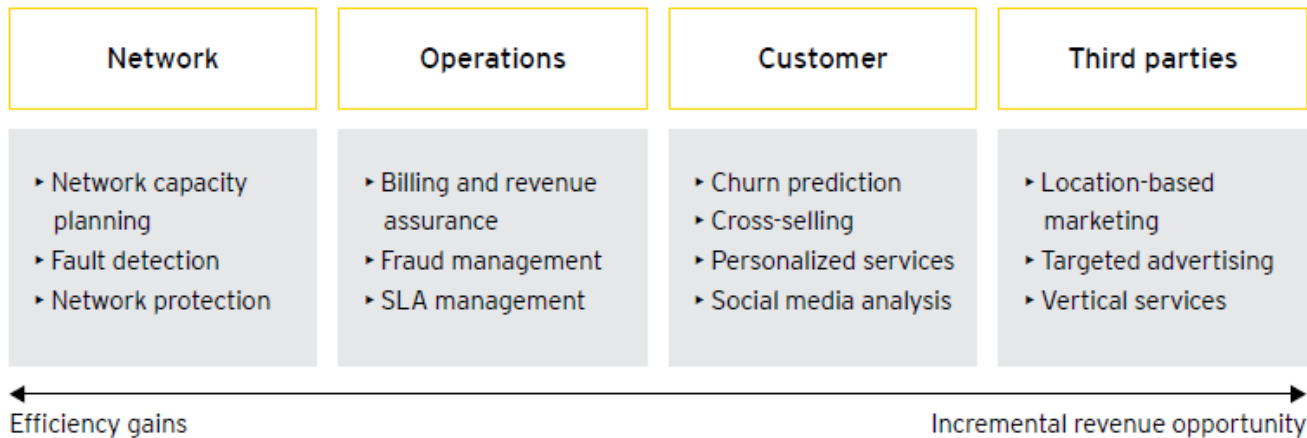

Source: EY analysis.

6. Lack of performance measurement to drive execution

- Turning digital strategy into business reality
 - Formulating the strategy is the easy part. Execution is much harder
 - Short-term business planning processes are often out of step with the long-term strategic visions
- New metrics to unlock measurable progress
 - To prioritize effective execution, operators must overhaul their business planning and metrics
 - Legacy KPIs — such as minutes of use (MOU) or average revenue per user (ARPU) fail to reflect pronounced changes in the revenue mix, tariff structures and multi-device ownership

7. Failure to understand what customers value

- Customer confusion limits appeal of new services
 - Significant proportion of consumers don't understand their mobile data tariffs with a correlation to try new services
 - Many operators emphasize higher speed as the main selling point while customers are actually more concerned with service reliability
- Balancing simplicity with flexibility in the proposition

8. Inability to extract value from network assets

- Addressing a wider mix of network technologies — and of potential rivals
 - Network landscape is increasingly heterogeneous
 - Mobile data offload using well established among mobile operators, other actors now see Wi-Fi opening up a range of benefits, from improved customer loyalty to the creation of new revenue streams via analytics and advertising.
 - New entrants are using innovative business models
 - Atmospheric satellites to provide wireless connectivity; ultra-narrow-band (UNB) radio to offer M2M services
- Driving more value from a heterogeneous network landscape
 - Where disruptive competitors are shifting their focus from services to infrastructure itself
 - Operators need roll out and manage a wider mix of technologies
 - Greater focus is required to provide a seamless customer experience
 - Use Small cells (to support reliable mobile data connectivity in both an indoor and outdoor environment, particularly for enterprises)
 - New technologies (5G, Li-Fi)

9. Poorly defined inorganic growth agenda

- Merges and Acquisitions (M&A) needs are evolving in new directions
 - New ways to build scale in the right areas, acquire capability and boost credibility
- Operators seek to make the most of a wider partnering landscape
 - partnerships are more important than ever as operators seek low-cost routes into new market segments or build scalability into existing service propositions
 - Horizontal partnerships (Mobile payments and marketing)
 - Vertical partnerships (SaaS providers)

10. Failure to adopt new routes to innovation

- Sourcing innovation at an earlier stage
 - engaging and interacting with the world of technology startups in new ways
 - Italy - €4.5m investments in a range of start-ups including digital and green ICT (TIM)
 - Brazil – INOVA TELECOM (Innovation in Telecommunication) – R\$ 1.5b investment (Enterprises and ICTs) - non refundable to ICTs
 - Looking to attract the best in new talent
- Attracting and sustaining a wider range of talent
 - Ability to attract and sustain new types of talent
 - Align talent with the strategic vision
- ALGAR Telecom Experience

ALGAR Telecom

- Optical Fiber Backbone - 12.000 km



ALGAR Telecom

- New talent attraction program
 - Winners of contests based on the “ACM International Collegiate Programming Contest” model
- Strong investment in teams
 - Certification Program
 - Post-graduate courses
 - Research and Development
- In House development of solutions
 - Replacement from solutions from vendors
- INOVA Telecom
 - 12 projects

Questions? Discussion!



Thank you!
Suggestions? Collaborations? Contact us!

flavio@ufu.br

Prof. Flávio de Oliveira Silva
FACOM – Faculdade de Computação
UFU - Universidade Federal de Uberlândia

International Expert Panel AICT/ICIMP 2014 (DataSys 2014 . . .)
Quality and Risk Assessment in Telecommunications Services

Managing Big Centers and Providing Mission Critical Services

The Advanced International Conference on Telecommunications (AICT 2014)
The International Conference on Internet Monitoring and Protection (ICIMP 2014)
July 22, 2014, Paris, France



Dr. rer. nat. Claus-Peter Rückemann^{1,2,3}



¹ Westfälische Wilhelms-Universität Münster (WWU), Münster, Germany

² Leibniz Universität Hannover, Hannover, Germany

³ North-German Supercomputing Alliance (HLRN), Germany

ruckema(at)uni-muenster.de



Status: Big centers - high end challenges

Big centers for computing, data, ... and 'mission critical'

- High End Computing, storage, and network services,
- Resources' provisioning – risk (Data? Loss of knowledge? ...),
- Change management, quality of .*, and big data challenges ...

High end challenges and insufficiencies ...

- Schism on marketing :: operation pretensions is increasing,
- Schism between research and industry,
- Services/economic issues vs. research,
- Hardware, software, networks, infrastructure,
- High availability vs. high efficiency vs. economic acquisition ...
- Local hierarchies vs. independent objective auditing,
- Deficits: Contracts, operation, staff layout, funding, legal regulations.
- Valuation of Q*: Quality regarding content and quality regarding support, Quality of Data (QoD), Quality of Service (QoS).

Vision – From Experiences to Management

Motivation: User / external / involved questions

- What is computer science and computing industry practically doing to cope with end to end challenges?
- Why is the schism between marketing and operation increasing?
- Why are technicians missing and researchers in resources' operation?
- How can future super-resources and services be efficiently created and operated?

Qualities and quantities

- Improve management, competence, transparency, auditing structures.
- Improve resources' and services' life cycles.
- Improve environments for structures, operation, and robustness.
- Improve “operation over marketing” & “data over technics”.
- Improve adding overall values (content, context, workflows).
- Implement evaluation, Quality-Assurance measures and QA inline.
- Implement Quality Control (QC), Quality by Design (QbD), Process Analytical Technologies (PAT), systematics, methodologies.

Conclusions

Quality, Management, and Provisioning

- **Top management should be selected independently, by assessment and proofable specialist expertise.**
- **Management decisions should be audited independently.**
- **Research driven over market (marketing) driven.**
- **Research and technical operation should be handled separately.**
- **Improvement cycles need to be audited independently.**
- **Contracts should define real requirements as mandatory goals.**
- **No wearout operation with mission critical environments, High End Computing, Supercomputing, Exa-scale, Zetta-tale.**
- **Best practice (knowledge, integration) anchored in funding.**
- **Sufficiency of staff and personnel to be audited.**
- **Quality-assurance measures and QA inline, QC, QbD, PAT.**
- **Experience and auditing-based quality improvement cycles (IT frameworks are no general remedy, ITIL and Co., . . .).**
- **Long-term resources planning (computing, storage, archive, . . .)**
- **Sustainable efficiently computation-aware “data”.**

Q&R Assessment in Telecommunications Services

AICT / ICIMP Panel INFOCOMP 2014

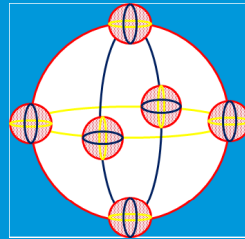

Complex Creo Simplex

Complex Civil Systems
Research Group &
Project Management
Programme

FACULTY OF
ENGINEERING &
INFORMATION
TECHNOLOGIES

A/Prof Dr Simon Reay Atkinson
University of Sydney



THE UNIVERSITY OF
SYDNEY

Identification, Classification, Categorisation

- › Identification: Synthetic Ecology:
 - 'A system (being or entity) that adapts, over time, by combining, through design and by natural processes, two or more dynamically interacting networks, including organisms, the communities they make up, and the non-living (physical and technological) mechanical components of their environment'.
- › Classification: Telecommunications Ecology:
 - 'A branch of ecology that focuses on the temporal-spatial, analogue-digital, electromagnetic transmission and reception of *information* and *data* between dynamically interacting networks and its relationship to the *socio-techno* scapes that surrounds it, both living and non-living'. SRA developed for INFOCOMP 2014.
- › Categorisation: Coordination Rule and Control (CRC) / Info/Techno-Socio (ITS):
 - Systems that seek to program [not programme] the relationship between technical processes and humans by digitizing performance fidelity and coding for repeatable *risk free* procedures in computer-control (cyber) spaces so that information, data and communication do not [temporally] contradict each other '.
- › Categorisation: Collaborative Social Influence (CSI) / Socio-Info/Techno (SIT)
 - 'Systems that stress the reciprocal interrelationship between humans and computers to foster improved shared awareness for agilely shaping the social programmes [not programs] of work, in such a way that humanity and ICT [control] programs do not contradict each other '.

- › **Risk** may be a function of both the ‘likelihood’ of an adverse event occurring and a system or person’s ability to comprehend, explain and understand by logic
- › **Trust** may be a function of the ‘likelihood’ of a person or system being able to comprehend, explain, understand by logic and deal with a set of outcomes or events.

- › **Relational (Ambidextrous) Trust** – combining CRC / ITS & CSI / SIT systems and comprising: *Situational [Aware] Decision Trust* in which people are entrusted to behave reliably in certain ways based upon system hierarchy, structures, rules and identified sources of power and *Trusting Intention* in which people behave reliably in ways based upon the common understanding of a systems hierarchy, its structures, rules and identified sources of power.

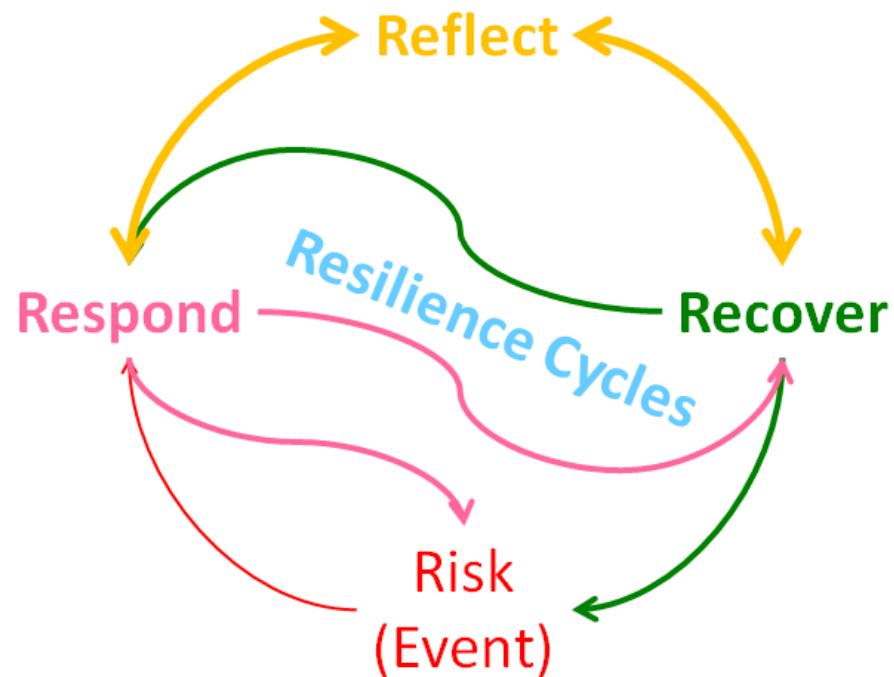

› Resilience:

- 'the *ability* of an ecology and / or system to *reflect*, adapt, transform, redesign, renew, and *recover* (bounce back) in a timely *response* to events'.

› Cyber may be:

- 'A technologically bounded, largely immeasurable, strongly scientific, stochastic *coordination, rule and control* scape comprising virtual-media and the display of data dealing with the *real* communication of *facts* and concurrently the *conceptualization* of alternative possibilities, themselves capable of generating hard physical and soft more *social* effects and *collaboratively influencing* them'

- › Frequently we are presented with situations where decisions need to be taken and yet when there is *uncertainty* as to how best to proceed. In other words, there is more than one solution and we are dealing, potentially, with a complex problem.
- › *Uncertainty* applies to probabilities, as in a Risk Register and to physical measurements that are already made, or to *known-unknowns*, *unknown-knowns* and *unknown-unknowns*. Specifically, we consider *Uncertainty* to:
 - ‘Arise in partially observable, opaque, stochastic environments / non-ergodic (complex) ecologies, overly prescribed, ruled or controlled regimes as well as due to lack of assurance, *instability*, ignorance and / or lack of caring and shared awareness; including indolence’:
- › *Instability* can create *Uncertainty* and *Uncertainty* can create *Instability* but they are not the same thing. *Instability* is:
 - ‘the quality or state of being *unstable* and / or the tendency to behave in an *unpredictable*, changeable, *uncertain*, or erratic manner’.

- › **Physical:** e.g. fire, earthquake, tsunami;
- › **Human:** e.g. war, politics, Global Financial Crisis; famine, social change etc;
- › **Technological:** e.g. Cyber, ICT and, potentially disruptive technologies such as nanotechnology;
- › **Complex:** some combination of Physical; Human, Social or Technological, (socio-info/techno or info/techno-socio) e.g. Morwell town disabled by the Brown Coal Fire.

- › Management & Control may be a function of *rules*, time, bandwidth and *fidelity*, whereas Command & Leadership may be a function of influence, *trust*, collaboration and *agility*.
- › Engineering / Technical Leadership is likely to be trust and influence based, exercising a reflective, conceptual and implicitly ability conscious, open, inclusive and informal decision making / taking style.

You can Lead / Command and Control / Manage...but not necessarily Control / Manage and Lead / Command!!!

Quesitio

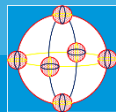

THE UNIVERSITY OF
SYDNEY