



The Twelfth International Conference on Adaptive and Self-Adaptive Systems and Applications
ADAPTIVE 2020
October 25, 2020 to October 29, 2020 - Nice, France

Computation
World
2020

Panel:

Adaptation, a Modus Vivendi Solution

(adaptable eco-systems, self-isolation adaptable avatars, sustainable adaptation, resilient adaptation, etc.)

Chair

Marc Kurz, University of Applied Sciences Upper Austria, Campus Hagenberg, Austria

Panellists

Stephan Kluth, FOM University of Applied Sciences, Germany

Jens Krösche, University of Applied Sciences Upper Austria, Campus Hagenberg, Austria

Stephan Selinger, University of Applied Sciences Upper Austria, Campus Hagenberg, Austria

Sebastian Lawrenz, Clausthal University of Technology, Germany

Technical Co-Sponsors and Logistic Supporters



ISSE | Institute for Software
and Systems Engineering





Panel 3

Adaptation, a Modus Vivendi Solution

(adaptable eco-systems, self-isolation adaptable avatars, sustainable adaptation, resilient adaptation, etc.)

Computation
World
2020

Panel Chair

Adaptation, a Modus Vivendi Solution

Marc Kurz, University of Applied Sciences Upper Austria, Campus Hagenberg, Austria. marc.kurz@fh-hagenberg.at

Adaptation in general is an important aspect in different areas. Important hereby is the fact that “adaptable” systems must be able to organize themselves by applying a certain “intelligent behavior” to allow for adaptation.

The current state, the context, goals and other environmental data that are about to be achieved play a crucial role - machine learning and artificial intelligence in general are the key to adaptation.

Relevant areas are very widespread – as the statements of the panelists show...

Marc is a Professor for Mobile Software Systems at the University of Applied Sciences Upper Austria, Faculty for Informatics, Communications and Media, Campus Hagenberg. He holds master- and PhD-degree from the University of Linz. His current research interests are (i) Activity & Context Recognition (i.e. Machine Learning, Pattern Classification, Opportunistic Sensing, Wearable and Mobile Sensors/Devices), (ii) Ambient Intelligence, (iii) Mobile Software Systems, Frameworks & Architectures, (iv) Adaptive & Self-Adaptive Systems (i.e. Collective Behavior, Semantic Modeling, Context-Aware Adaptation), (v) Distributed & Autonomic Computing (i.e. Distributed Software & Algorithms, Component Technologies/Frameworks, Service-Oriented Frameworks, Ad-hoc Interaction, Self- Organization & Self-Management, and (vi) Mobile User Interaction.





Panel 3

Adaptation, a Modus Vivendi Solution

(adaptable eco-systems, self-isolation adaptable avatars, sustainable adaptation, resilient adaptation, etc.)

Computation
World
2020

Panellist Position

Performance Predictions for Adaptive Systems

Stephan Kluth, FOM University of Applied Sciences, Germany, mail@stephankluth.de

- Hierarchical modeling and analysis as a key to complexity reduction
- Different perspectives on modeled system
- Usage of well-known Laws (Forced Traffic Flow Law and Little's Law)
- Simple and scalable performance prediction algorithm
- Usage in adaptive systems to predict and (self-)adapt performance goals and parameters





Panel 3

Adaptation, a Modus Vivendi Solution

(adaptable eco-systems, self-isolation adaptable avatars, sustainable adaptation, resilient adaptation, etc.)

Computation
World
2020

Panellist Position

Identifying the Key Challenges and Factors to Open the Door for Adaptation

Jens Krösche, University of Applied Sciences Upper Austria jens.Kroesche@fh-ooe.at

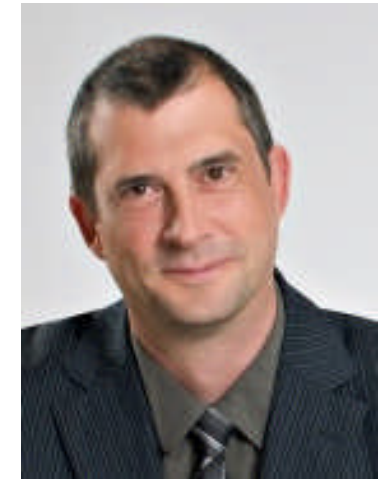

As today's society is more and more relying on smart-phones, -devices, -assistants and -applications the amount of adaptable systems is increasing in nearly every corner of our daily life. But what aspects make an adaptable system successful, what preconditions and mechanisms are necessary to build a useful service/system and when do users accept/value an adaptation? As many of these questions are still part of a fluctuating research environment, it is important to start summarizing knowledge already gained to foster new developments.



Panel 3

Adaptation, a Modus Vivendi Solution

(adaptable eco-systems, self-isolation adaptable avatars, sustainable adaptation, resilient adaptation, etc.)

Computation
World
2020

Panellist Position

Automated Generation and Adaptation of Periodized Training Plans in Endurance Sports

Stephan Selinger, University of Applied Sciences Upper Austria, Hagenberg stephan.selinger@fh-hagenberg.at



In contrast to high-performance sports, athletes in amateur sports are often not coached by professional trainers. Apart from the risk of overtraining with all the health and sporting consequences, training without an annual training plan tailored to an athlete's level of development leads to less than optimal performance development. The creation and constant adaptation of a training plan is a demanding task that requires an experienced coach with sufficient domain knowledge.

Therefore, not surprisingly, various approaches are described in the literature which are capable of automatically creating a training plan. However, none of those approaches supports the concept of periodization, i.e., the precise modulation of training volume and intensity during the training year.

We propose an extension of an existing approach that is based on Particle Swarm Optimization to create an annual training plan that takes various periodization strategies into account.



Panel 3

Adaptation, a Modus Vivandi Solution

(adaptable eco-systems, self-isolation adaptable avatars, sustainable adaptation, resilient adaptation, etc.)

Computation
World
2020

Panellist Position

We have to design our Systems in the future more sustainable!

Evolving Software Ecosystems and Services

Sebastian Lawrenz, IARIA, EU/Germany Sebastian.Lawrenz@tu-clausthal.de

- Software ecosystems in practical environments
- Sustainable Ecosystems will become more and more important
- Data and Knowledge Exchange and Trading is a key component

→ Sustainable Ecosystems – a Driver Towards the
Circular Economy





UNIVERSITY
OF APPLIED SCIENCES
UPPER AUSTRIA

Panel

Adaptation, a Modus Vivendi Solution

Marc Kurz

Computation World 2020 | October 2020

marc.kurz@fh-hagenberg.at

HAGENBERG | LINZ | STEYR | WELS



Introduction :: Statement

- Adaptation of systems to different circumstances is important in different areas
 - > Requires **self-organization**, **self-management**, and general **self-* capabilities**
- „**Intelligent Behavior**“ necessary to be able to adapt autonomously
 - > **Environmental** and **contextual data** required to be able to infer the current situation and adapt accordingly
- Progress in recent years in the areas of „**Artificial Intelligence**“ and „**Machine Learning**“ opens the door for “real” autonomous adaptation of intelligent systems
 - > *Thus, we are only at the beginning....*

Related Work

- J. O. Kephart and D. M. Chess. “**The vision of autonomic computing**”, 2003.

Concept	Current computing	Autonomic computing
Self-configuration	Corporate data centers have multiple vendors and platforms. Installing, configuring, and integrating systems is time consuming and error prone.	Automated configuration of components and systems follows high-level policies. Rest of system adjusts automatically and seamlessly.
Self-optimization	Systems have hundreds of manually set, nonlinear tuning parameters, and their number increases with each release.	Components and systems continually seek opportunities to improve their own performance and efficiency.
Self-healing	Problem determination in large, complex systems can take a team of programmers weeks.	System automatically detects, diagnoses, and repairs localized software and hardware problems.
Self-protection	Detection of and recovery from attacks and cascading failures is manual.	System automatically defends against malicious attacks or cascading failures. It uses early warning to anticipate and prevent systemwide failures.

Related Work

- Nagabandi, Anusha, et al. "**Learning to adapt in dynamic, real-world environments through meta-reinforcement learning**", 2018
 - > approach for model-based meta-RL that enables fast, online adaptation of large and expressive models in dynamic environments
 - > to adapt to unseen situations or sudden and drastic changes in the environment, and is also sample efficient to train

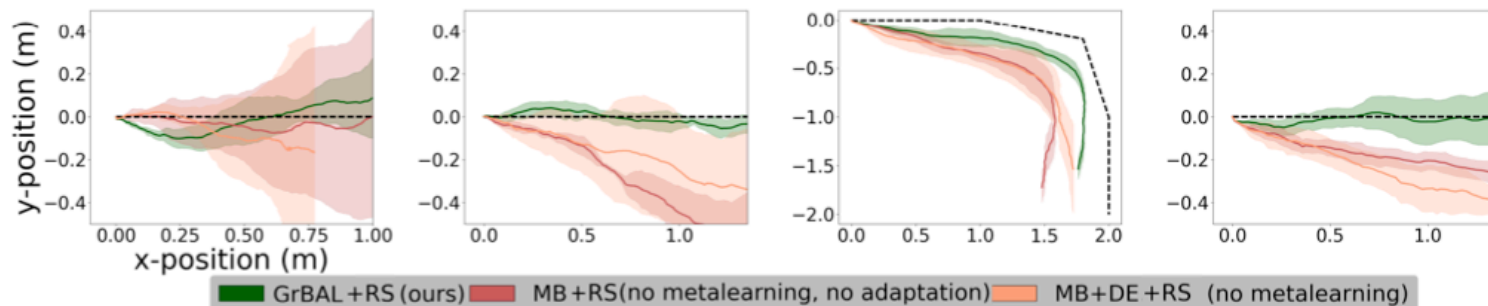

Related Work

- Moreira, Rui S., et al. "**Dynamic adaptation of personal ubicomp environments**", 2016
 - > Special Issue: challenge for personal and ubiquitous computing is to cope with
 - frequent changes of user preferences
 - Profile
 - Location
 - and context in general
 - > dynamic adaptation is being used to address this challenge

Related Work

- Byun, Hee Eon, and Keith Cheverst. **"Utilizing context history to provide dynamic adaptations"**, 2004
 - > In order to provide "intimate" and "dynamic" adaptations under Weiser's vision for ubiquitous computing environments, we propose the utilization of context history together with user modeling and machine learning techniques.

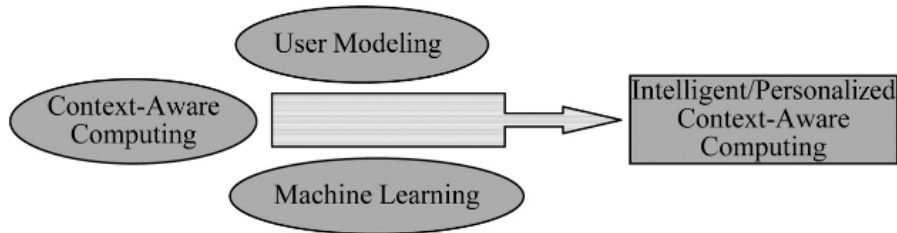

Related Work

- Jamshidi, Pooyan, et al. "**Machine learning meets quantitative planning: Enabling self-adaptation in autonomous robots**", 2019.
 - > Assumptions about parts of the system made at design time may not hold at run time, especially when a system is deployed for long periods (e.g., over decades)
 - > Self-adaptation is designed to find re- configurations of systems to handle such run-time inconsistencies.

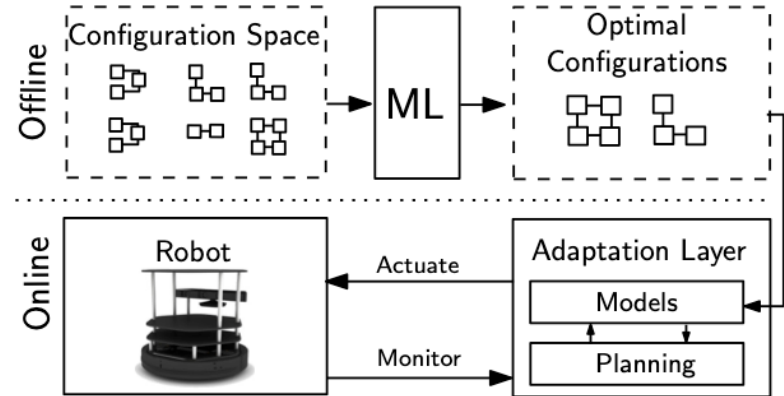

Related Work

- Kurz, Marc, Gerold Hölzl, and Alois Ferscha. "**Dynamic adaptation of opportunistic sensor configurations for continuous and accurate activity recognition**", 2012.
 - > Opportunistic activity recognition - sensor systems that gather environmental data to infer people's activities are not presumably known at design time
 - > System has to autonomously adapt to the dynamic sensing infrastructure

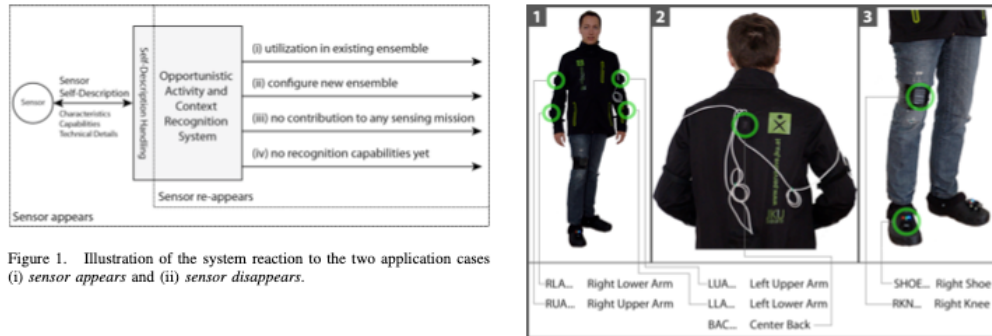

Conclusion

- With recent advancements in AI and ML research, we are currently at the beginning of employing “**autonomous adaptation**”
- Relevant areas are very **widespread** as related work shows, some examples:
 - > Robotics
 - > Pervasive/ubiquitous computing
 - > Context/autonomic computing
 - > Industrial applications
- *By interweaving ML/AI with relevant data and adaptation mechanism, we will open the door to a new challenging field, full of open research questions....*



UNIVERSITY
OF APPLIED SCIENCES
UPPER AUSTRIA

Panel

Adaptation, a Modus Vivendi Solution

Marc Kurz

Computation World 2020 | October 2020

marc.kurz@fh-hagenberg.at

HAGENBERG | LINZ | STEYR | WELS





Performance Predictions for Adaptive Systems

Panellist Position | ComputationWorld 2020

Stephan Kluth

FOM University of Applied Sciences

mail@stephankluth.de - https://www.xing.com/profile/Stephan_Kluth

Multidimensional System Perspectives

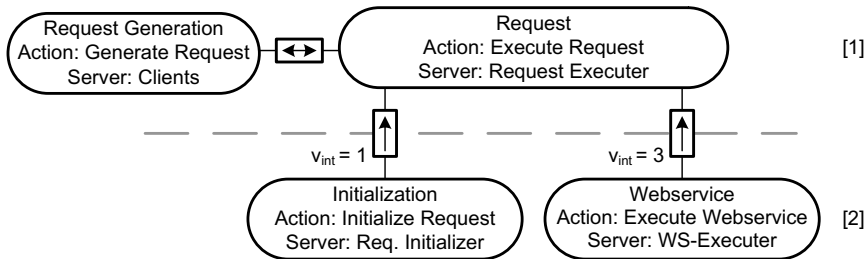

Service Request Structures

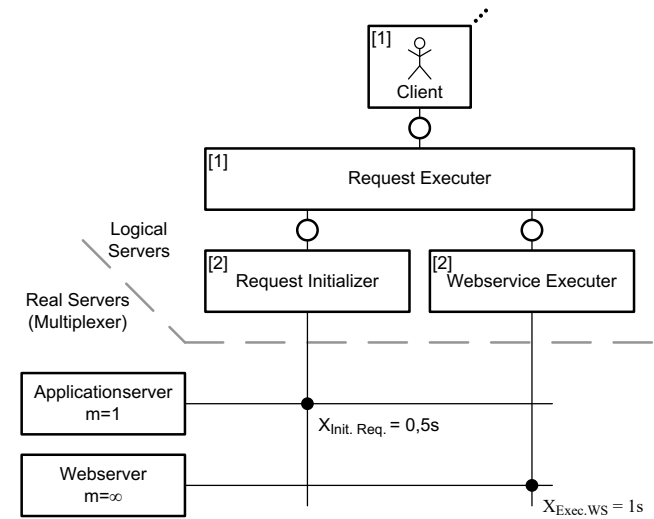

Server Structures

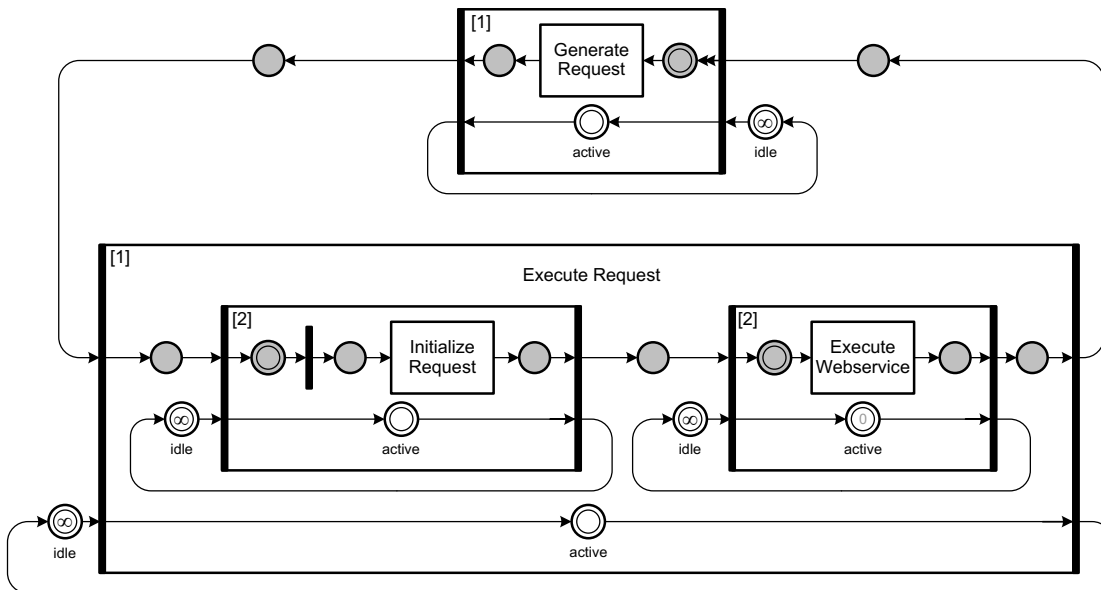

Dynamic Behavior and Control Flow

- Hierarchical Modeling^{3,4}
- Multidimensional System view
- Distinction of operational- and control states

3,4: see Slide 4

- Hierarchical interpretable structure for performance prediction

- Usage of well-known laws:
 - Little's Law¹ $N^{[bb]} = \lambda^{[bb]} * R^{[bb]}$ within one hierarchical level
 - $N^{[bb]}$: Normalized service request on hierarchical level [bb]
 - $\lambda^{[bb]}$: Arrival rate of service request SRq on hierarchy level [bb] (Unit: [SRq/Timeunit])
 - $R^{[bb]}$: Response time of the server of the service request on hierarchy level [bb]
 - Forced Traffic Flow Law² $\lambda_{int}^{[bb]} = v_{int}^{[bb]} * \lambda_{ext}^{[bb-1]}$ as a bridge between hierarchical levels
 - $\lambda_{int}^{[bb]}$: internal arrival rate of service request SRq on hierarchy level [bb]
 - $v_{int}^{[bb]}$: internal traffic flow coefficient
 - $\lambda_{ext}^{[bb-1]}$: external arrival rate of service request SRq on hierarchy level [bb]

¹: J. D. C. Little, "A Proof of the Queueing Formula $L = \lambda * W$," Operations Research, vol. 9, no. 3, pp. 383–387, May – June 1961.

²: P. J. Denning and J. P. Buzen, "The Operational Analysis of Queueing Network Models," ACM Computing Surveys (CSUR), vol. 10, no. 3, pp. 225–261, September 1978.

FMC-QE^{3,4} Calculus

- Simple and scalable performance prediction algorithm
- predictions could be integrated into the algorithms of self-adaptive systems, while the hierarchical approach reduces the complexity dramatically
- performance predictions are integrated into a spreadsheet but are not limited to this
- performance predictions could be used to adapt performance parameters

Experimental Parameters:	
n_{ges}	30
λ_{bott}	2,0000
f	0,8000
λ	1,6000

Service Request Section							Server Section					Dynamic Evaluation Section						
[bb]	SRq _i ^[bb]	p _{[bb-1],i}	v _{i,ext} ^[bb-1]	v _{i,int} ^[bb]	v _i ^[bb]	λ_i ^[bb]	Server _i	X _{i,measured} ^[bb]	m _{i,ext} ^[bb-1]	m _{i,int} ^[bb]	m _i ^[bb]	X _{i,mpxed} ^[bb]	μ_i ^[bb]	ρ_i ^[bb]	n _{i,q} ^[bb]	n _{i,s} ^[bb]	n _i ^[bb]	R _i ^[bb]
2	Webservice	1	1	3	3	4,8000	Webserver	1,0000	1	1	1	1,0000	1,0000		0,0000	4,8000	4,8000	1,0000
2	Initialization	1	1	1	1	1,6000	App. Server	0,2000	1	1	1	0,5000	2,0000	0,8000	3,2000	0,8000	4,0000	2,5000
1	Request	1	1	1	1	1,6000			1	1	1	2,0000			3,2000	5,6000	8,8000	5,5000
1	Request Generation	1	1	1	1	1,6000			1	1	1	13,2500	0,0755		0,0000	21,2000	21,2000	13,2500

Multiplexer Section				
Multiplexer _j	m _j	X _j ^[1]	μ_j ^[1]	μ_j ^[1] *m _j
App. Server	1	0,5000	2,0000	2,0000
Webserver	∞	1,0000		

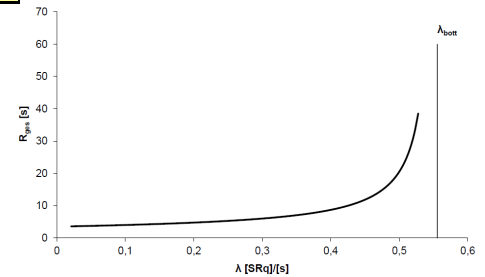

³: W. Zorn, "FMC-QE - A New Approach in Quantitative Modeling," in Proceedings of the International Conference on Modeling, Simulation and Visualization Methods (MSV 2007) within WorldComp '07, H. R. Arabnia, Ed. Las Vegas, NV, USA: CSREA Press, June 2007, pp. 280 – 287.

⁴: S. Kluth, "Quantitative Modeling and Analysis with FMCQE," Ph.D. dissertation, Hasso Plattner Institute for Software Systems Engineering at the University of Potsdam, Potsdam, Germany, July 2011.

References

This presentation is connected to the following publication:

Stephan Kluth:

Performance Predictions for Adaptive Cloud-Based Systems using FMC-QE

The Twelfth International Conference on Adaptive and Self-Adaptive Systems and Applications (ADAPTIVE 2020 – Nice, France, October 2020)

available through ThinkMind digital library

All further references are to be found in this publication.



Panel 3

Adaptation, a Modus Vivendi Solution

(adaptable eco-systems, self-isolation adaptable avatars, sustainable adaptation, resilient adaptation, etc.)

Computation
World
2020

Panellist Position

Identifying the Key Challenges and Factors to Open the Door for Adaptation

Jens Krösche, University of Applied Sciences Upper Austria jens.Kroesche@fh-ooe.at

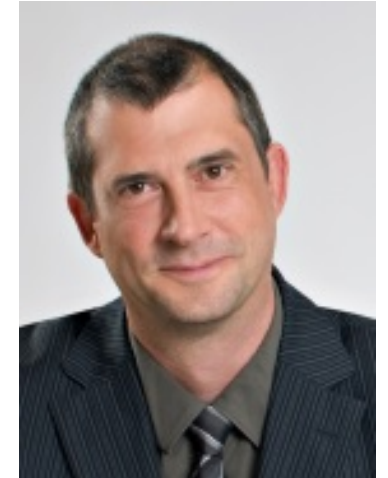

As today's society is more and more relying on smart-phones, -devices, -assistants and -applications the amount of adaptable systems is increasing in nearly every corner of our daily life. But what aspects make an adaptable system successful, what preconditions and mechanisms are necessary to build a useful service/system and when do users accept/value an adaptation? As many of these questions are still part of a fluctuating research environment, it is important to start summarizing knowledge already gained to foster new developments.



Identifying the Key Challenges and Factors to Open the Door for Adaptation

- **Motivation**

- Adaptive Systems are more and more to be found in the general environment
 - Car automatically adjusts seats matching the person
 - Navigation systems adapt the map scale or office programs highlight menu features typically used
 - Home automation system adapts light situation due to the users preferences and/or mood
 - Smartphones suggest apps to be used next
 - ... and many more
- Nevertheless, not all trials end successful, but why ...



Identifying the Key Challenges and Factors to Open the Door for Adaptation

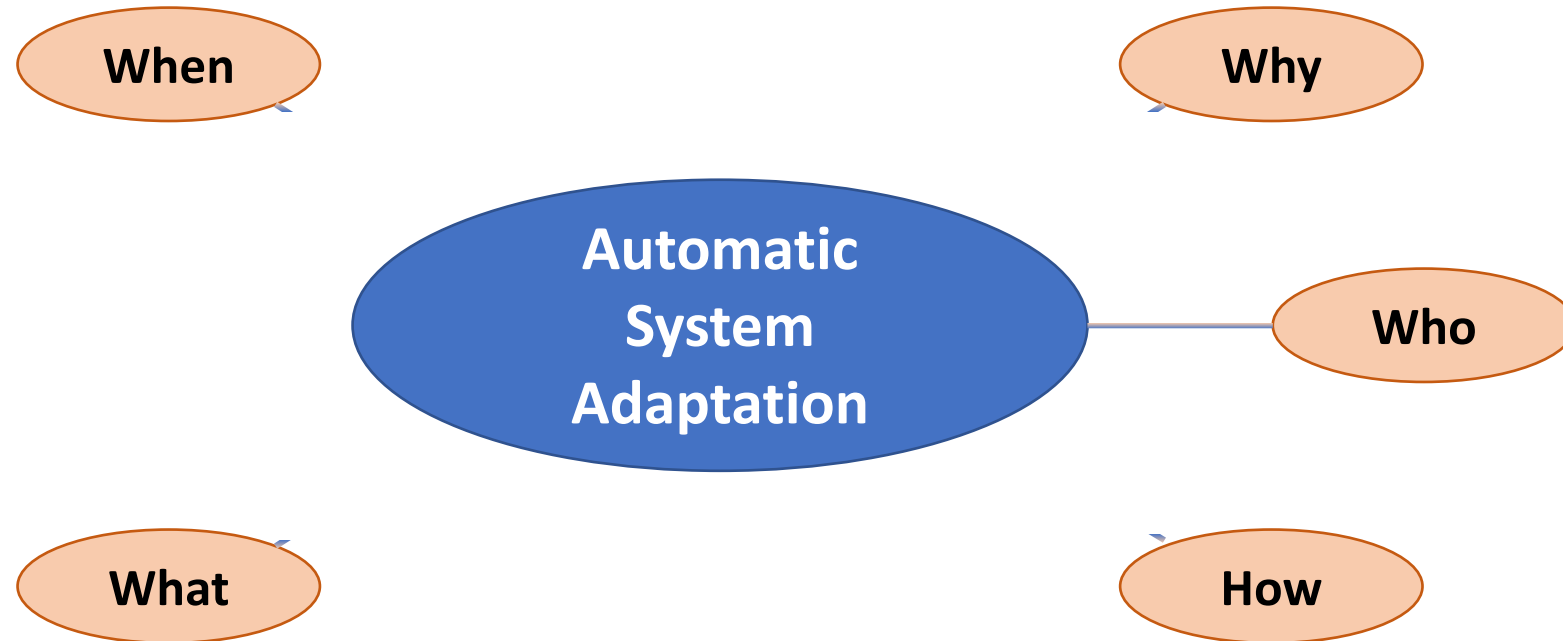



Identifying the Key Challenges and Factors to Open the Door for Adaptation

- **When**

In what situations should the system adapt?

- Challenges:
 - Different parallel goals with perhaps contradicting adaptations
 - Different priorities for different goals
 - Adapting to low-level goal might conceal primary target
 - Is the adaptation an expected behaviour

- **Why**

Why is the system adapting itself?

- Challenges:
 - Perceiving and managing the relevant factors (context)
 - Managing different perception horizons (user vs. system/environment)
 - Reducing adaptation surprise, especially for non digital natives
 - Fostering the system comprehension
 - Taking into account that users may feel powerless
 - Is the adaptation considered useful, which strongly depends on the individual and its goals



Identifying the Key Challenges and Factors to Open the Door for Adaptation

- **Who**

Who is doing the adaptation?

- Challenges:
 - Trustworthiness of external systems (cloud services not only knowing what I am interested in, but also what I need it for (my goals))
 - Is the system adapting the environment or the other way around
 - Processing power and or abilities of the local system (hardware vs. software)

- **How**

How is the adaptation defined?

- Challenges:
 - Predefined adaptation may not suit every element of target group
 - Reproducibility of the adaptation in a learning environment
 - Fine-tuning adaptation for the individual



Identifying the Key Challenges and Factors to Open the Door for Adaptation

- **What**

What is adapted?

- Challenges:
 - Does the system adapt parts of the environment or the other way around
 - What parts of a environment/system are adapted
 - Content
 - Structure
 - UI
 - To whom (if multiple entities are present)
- What if the adaptation does not suit the users' needs



Identifying the Key Challenges and Factors to Open the Door for Adaptation

- **In General**

- To foster approval for adapting systems
 - Start small
 - Keep the surprise level low
 - Provide some insight
 - Give users the power
- Missing (industrial) standards regarding
 - Context
 - Goals
 - Communication
 - Reasoning



UNIVERSITY
OF APPLIED SCIENCES
UPPER AUSTRIA

Automated Generation and Adaptation of Periodized Training Plans in Endurance Sports

Stephan Selinger, stephan.selinger@fh-hagenberg.at

University of Applied Sciences Upper Austria
School of Informatics, Communications and Media
Hagenberg, Austria

HAGENBERG | LINZ | STEYR | WELS



Introduction

- In contrast to high-performance sports, **athletes in amateur sports** are often not coached by professional trainers
 - Overtraining
 - Sub-optimal form
- Annual training plans are usually developed by experienced coaches with domain knowledge
 - Recently, **software** products that can at least automatically **create a plan** begin to emerge in endurance sports such as running or cycling (e.g., <https://runningcoach.me/>, <https://connect.garmin.com/>)
 - Initial creation of the plan is relatively easy, e.g., based on ACSM guidelines
 - Constant **adaptation** of the plan is needed – what is the best way to resume training after an injury or illness, for example, and how quickly do you increase it?

Related Work

- I. Fister Jr. et al. Computational intelligence in sports: Challenges and opportunities within a new research domain. Applied Mathematics and Computation. Volume 262, 1 July 2015, pages 178-186.
- Propose a model of an **artificial trainer** to
 - generate a plan,
 - adapt the plan according to external and internal factors,
 - measure an athlete's form,
 - analyze the data produced by mobile tracking devices.

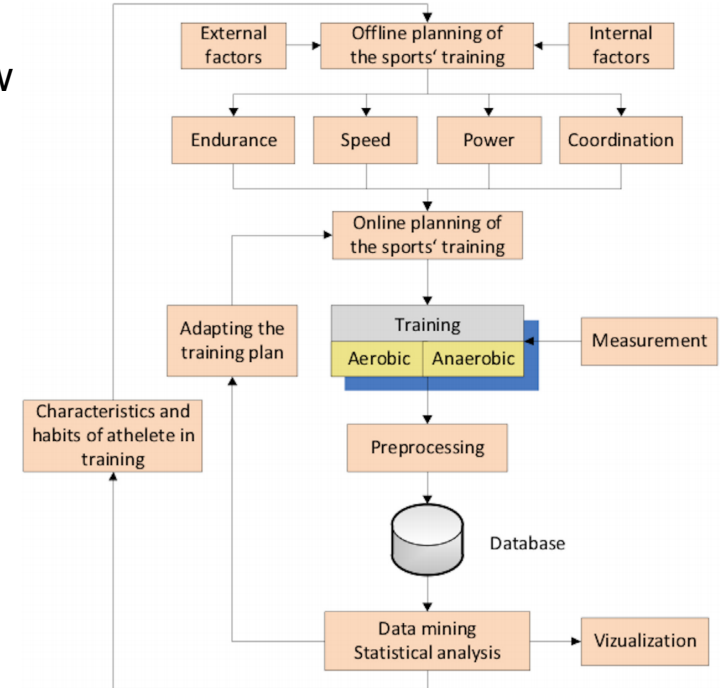

Related Work

- Kumyaito, N., Yupapin, P. & Tamee, K. Planning a sports training program using Adaptive Particle Swarm Optimization (PSO) with emphasis on physiological constraints. BMC Res Notes 11, 9 (2018).
 - Creates an **8-week training plan** for cyclists based on average heart-rate, and activity duration
 - Based on Morton's and Banister's TRIMP and fitness/fatigue model to describe an athlete's reaction to training
 - Performs better than a standard training plan by British Cycling

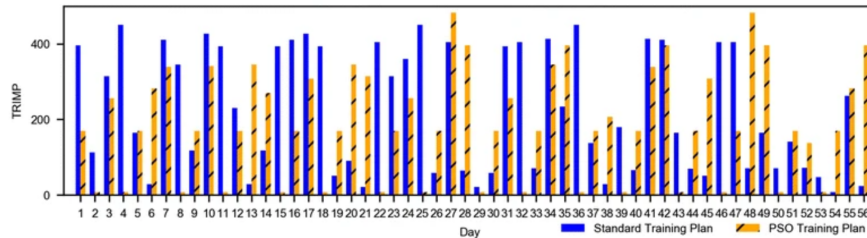

Periodization

- Athletes can not compete at peak performance for longer than a few weeks
- Periodization, i.e., the break-down of the annual training plan in phases such as **preparation**, **competition**, and **recovery**, is believed to help athletes reach their peak performance in the most important competition
- Depending on the phase, **volume and intensity** are modulated

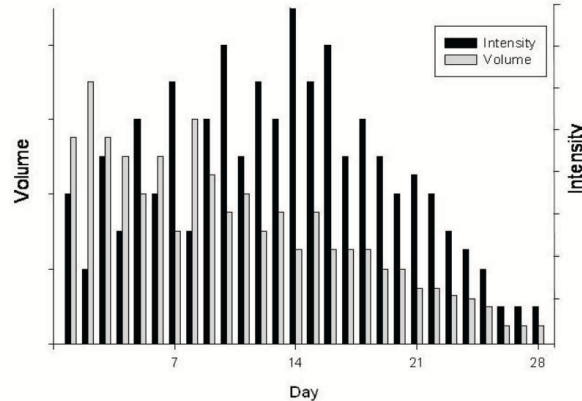
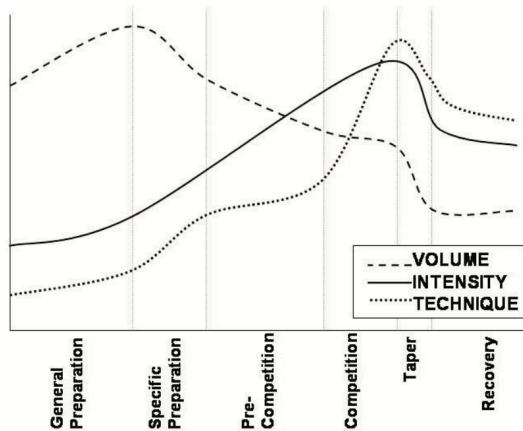

Signorile, Joseph. (2007). Periodized training for the master athlete. Functional U: Exercise and Activity for Healthy Aging. 5. 1-13.

Extending Kumyaito's Approach to Consider Periodization

- Kumyaito et al. prescribe a training plan based on TRIMP, i.e., conceptually the product of average heart-rate and duration; how a certain TRIMP is achieved (long duration with low average heart-rate, or the opposite) is not considered.
 - PSO optimization uses Morton's and Banister's fitness fatigue model as objective function, and physiological constraints such as
 - > training monotony (variance of TRIMP of past training sessions)
 - > chronic training load (CTL) ramp rate, and
 - > maximum daily TRIMP
- We propose to **extend the approach by Kumyaito et al.** by considering **periodization**
 - The annual training plan is broken down in distinct phases with distinct **volume/intensity** ratios, which are considered as additional constraints

Extending Kumyaito's Approach to Consider Periodization

- In accordance with Fister's artificial trainer model, we measure the performed trainings (TRIMP) and adapt the training plan by
 - Running the Kumyaito algorithm repeatedly and considering the performed training, as well as
 - considering periodization, i.e., depending on the period we are in, additional volume/intensity constraints are provided
- Proposed extension (bold)

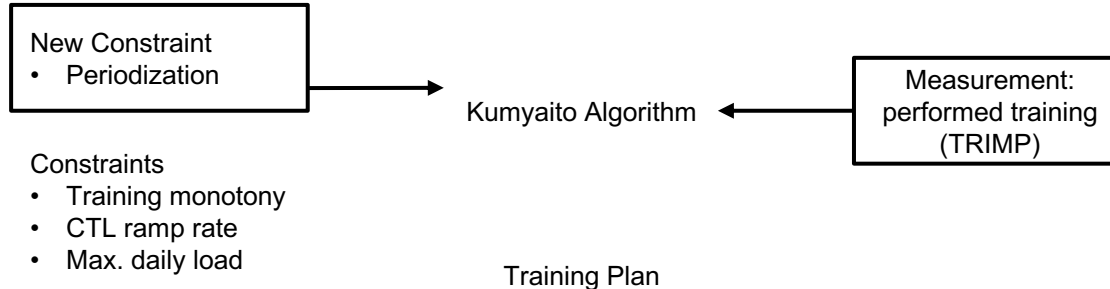

Conclusion and Outlook

- By running the PSO optimizer repeatedly, the training plan
 - **adapts** itself to the **performed training**, and by considering a specific
 - **periodization model**, volume and intensity is modulated as in a traditional training plan
- Since not only the development of endurance is crucial to athletic development, at least
 - **strength** and
 - **flexibility** training has to be incorporated into the automatic creation of a training plan.

Sustainable Ecosystems – a Driver Towards the Circular Economy

Panellist Position | Adaptive 2020

Sebastian Lawrenz

sebastian.lawrenz@tu-clausthal.de



Sustainable adaptive Ecosystems

- Digital transformation and software engineering play a key role towards more sustainability
- Especially, adaptive Systems and (sustainable) Software Ecosystems
- Our task should be to design *sustainable systems*

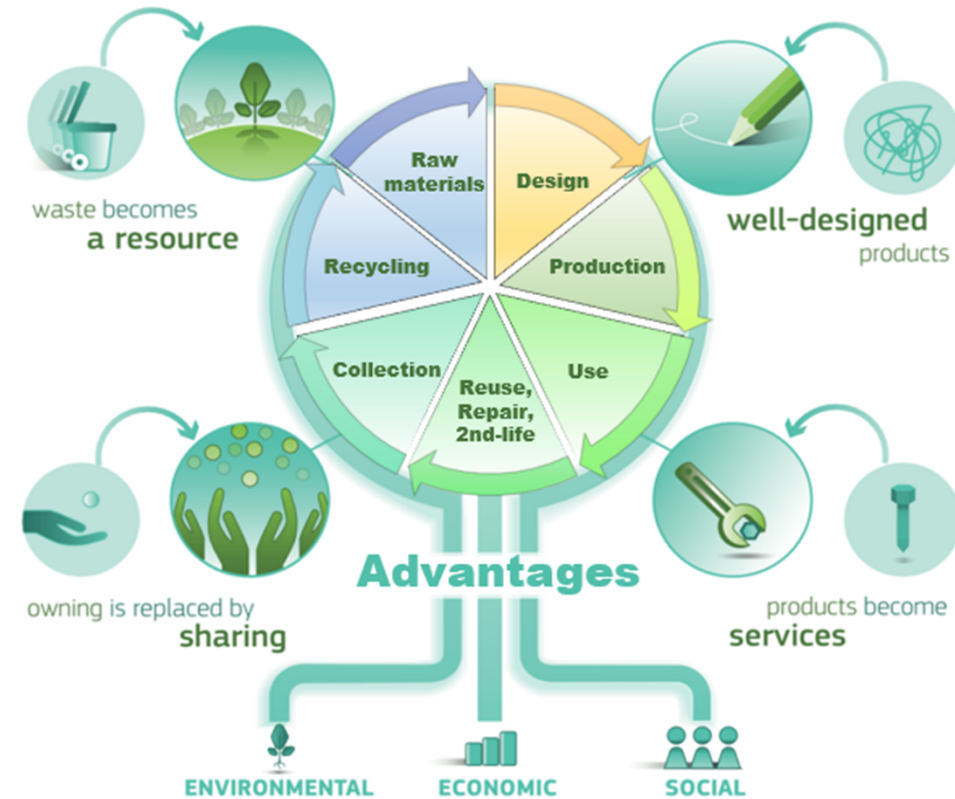

Overview and advantages of the Circular Economy

Some barriers on the way towards more sustainability

■ Knowledge Gaps

- Repair instructions
- Recycling knowledge
- Material composition of products

■ Missing Motivation

- A sustainable lifestyle is expensive
- Business models are oriented towards economic not ecological
- Laziness

■ Information Gaps

- Information about the products, for example

■ No reasons to change the status quo yet

New Kinds of Ecosystems?

- New business ecosystems emerge
 - Blockchain technology and distributed ledger technologies
- Innovation ecosystems
 - Adaptive dismantling ecosystems
 - Software ecosystems in the mining industry
 - Catalog-based platform for simulation models
- Services and Software Ecosystems
 - Software architecture degradation mitigation by machine learning
 - Adaptive & emergent IoT Ecosystems
- Further Information:
 - ESES: Evolving Software Ecosystems and Services

Architectural Proposal for an Emergent Ecosystem Design

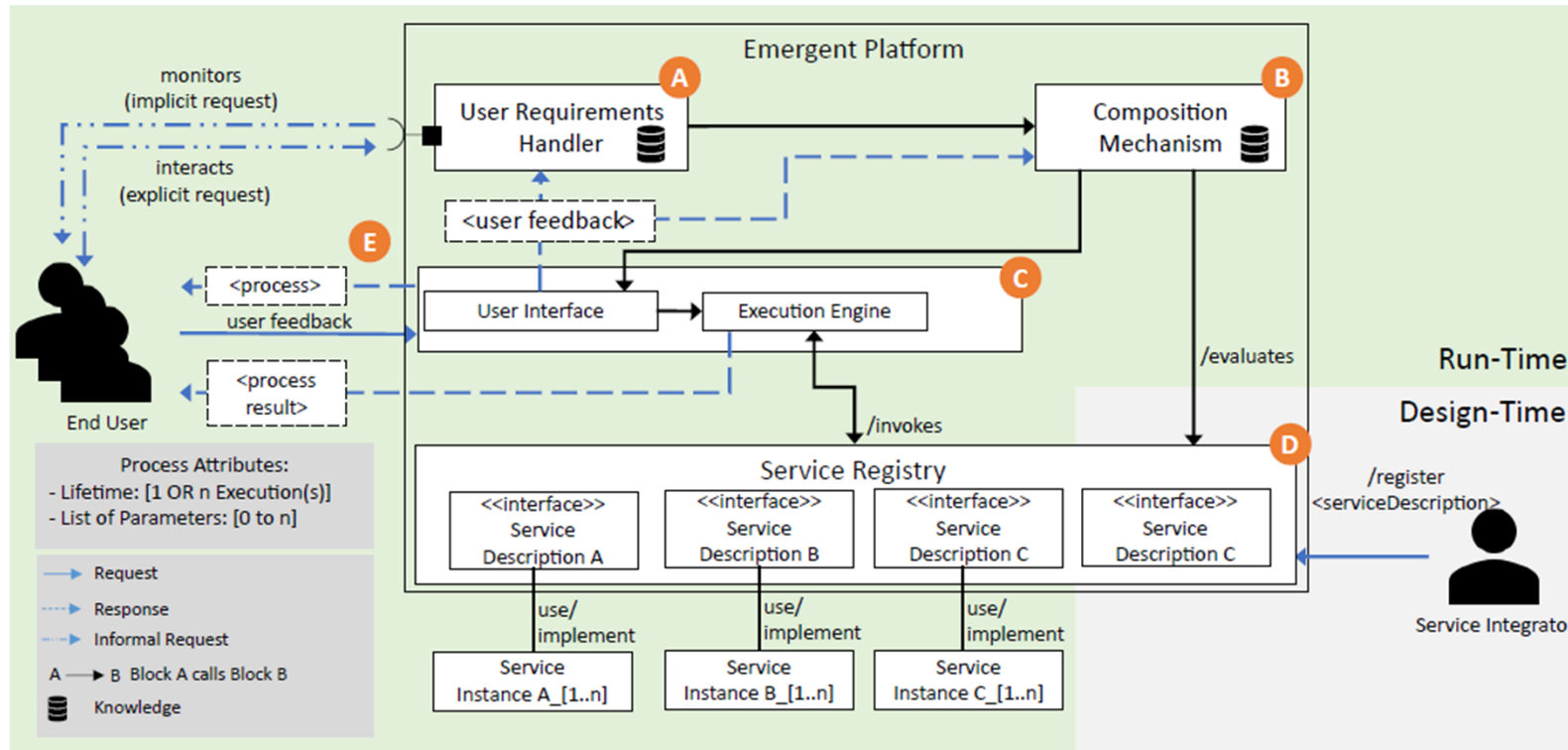

- Applications provided by software intensive systems in an Internet of Things environment offer new business opportunities
- The picture shows a new architecture to adapt future emergent and adaptive (eco) systems

Source: Wilken, N., Toufik, M., Christian, A., Fabian, B., Christoph, B., et al., 2020, Dynamic Adaptive System Composition Driven By Emergence in an IoT Based Environment : Architecture and Challenges, Proc. 12th Int. Conf. on Adaptive and Self-Adaptive Systems and Applications (ADAPTIVE2020).

Information Marketplace in the Context of a Recycling Ecosystem

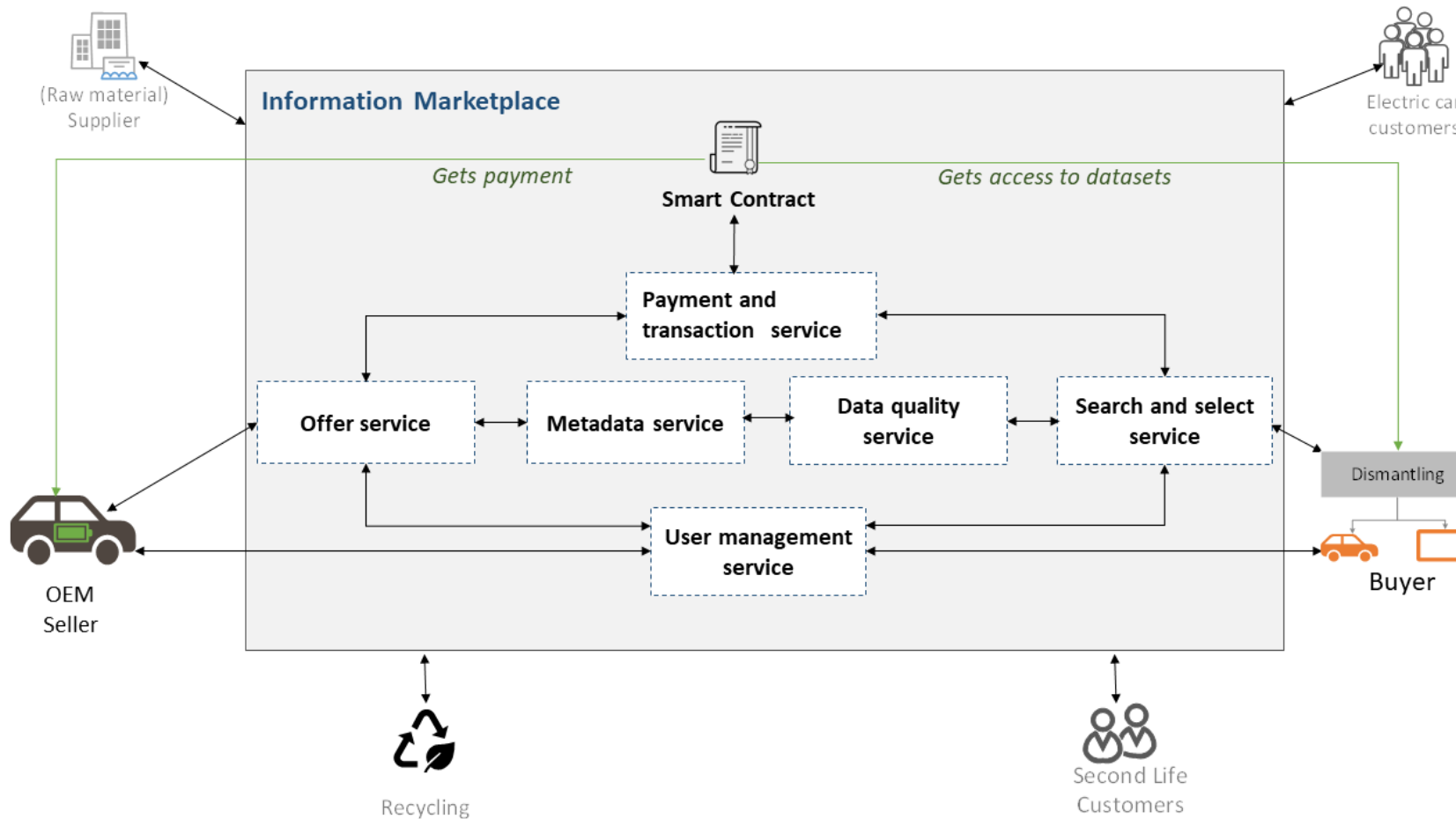

- Information gaps are one of the main barriers in the recycling domain
- An information marketplace manages to bridge this barrier

Source: [S. Blömeke, M. Mennenga, C. Herrmann, C. Scheller, T. Spengler, M. Nippraschk, D. Goldmann, S. Lawrenz, P. Sharma, A. Rausch, H. Poschmann, H. Brügemann, L. Kintscher, G. Bikker. 2020 Recycling 4.0 An Integrated Approach Towards an Advanced Circular Economy In ICT4S'20: 7th International Conference on ICT for Sustainability, June 21--26, 2020, Bristol, United Kingdom](https://doi.org/10.1145/3401335.3401666)

Combining Ecosystems and Adaptive Systems to Achieve a Circular Economy Ecosystem

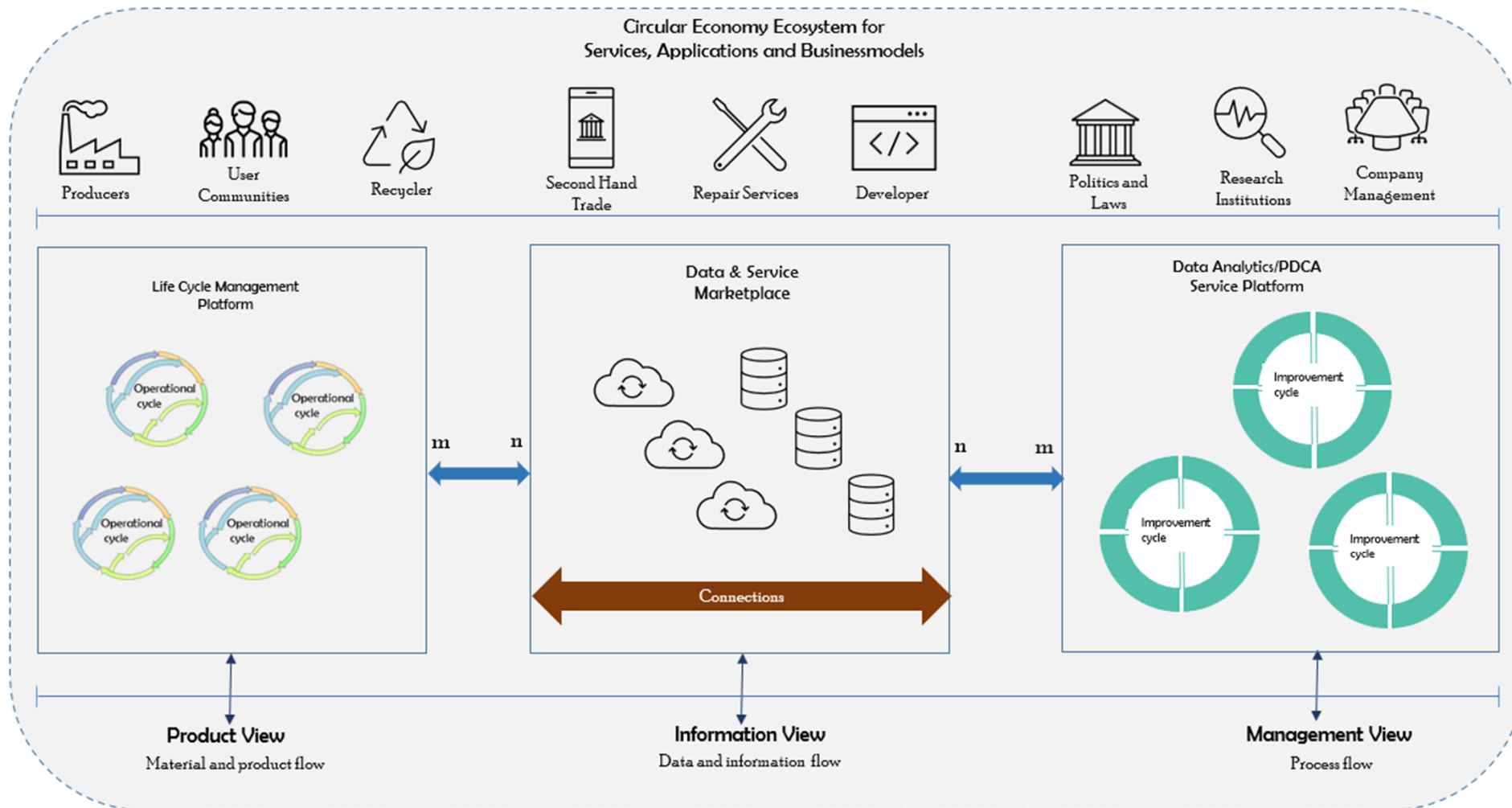

Key Questions in Sustainable Ecosystems Design?

- Are we aware what we are building?
- Are we able to extend the system?
- Did we choose the right balance between technical progress and sustainability?

